



# Citibank Basic Materials Conference

*New York, NY*

*November 28, 2017*



# Forward-Looking Statements



This communication includes forward-looking statements. These statements relate to analyses and other information that are based on management's beliefs, certain assumptions made by management, forecasts of future results, and current expectations, estimates and projections about the markets and economy in which we and our various segments operate. These statements may include statements regarding our October 5, 2015 acquisition of the U.S. chlor alkali and downstream derivatives businesses (the "Acquired Business"), the expected benefits and synergies of the transaction, and future opportunities for the combined company following the transaction. The statements contained in this presentation that are not statements of historical fact may include forward-looking statements that involve a number of risks and uncertainties.

We have used the words "anticipate," "intend," "may," "expect," "believe," "should," "plan," "project," "estimate," "forecast," "optimistic," and variations of such words and similar expressions in this release to identify such forward-looking statements. These statements are not guarantees of future performance and involve certain risks, uncertainties and assumptions, which are difficult to predict and many of which are beyond our control.

Therefore, actual outcomes and results may differ materially from those matters expressed or implied in such forward-looking statements. Factors that could cause or contribute to such differences include, but are not limited to: our sensitivity to economic, business and market conditions in the U. S. and overseas; higher-than-expected raw material and energy, transportation, and/or logistics costs; our substantial amount of indebtedness and significant debt service obligations; our reliance on a limited number of suppliers for specified feedstock and services and our reliance on third-party transportation; failure to control costs or to achieve targeted cost reductions; the occurrence of unexpected manufacturing interruptions and outages; changes in legislation or government regulations or policies; unexpected litigation outcomes; the integration of the Acquired Business not being successful in realizing the benefits of the anticipated synergies; adverse conditions in the credit and capital markets; the failure to attract, retain and motivate key employees; and the other risks detailed in Olin's Form 10-K for the fiscal year ended December 31, 2016 and Olin's Form 10-Q for the quarter ended September 30, 2017. All of the forward-looking statements should be considered in light of these factors. In addition, other risks and uncertainties not presently known to Olin or that Olin considers immaterial could affect the accuracy of our forward-looking statements. The reader is cautioned not to rely unduly on these forward-looking statements. All references to expectations for 2017 are based on expectations at October 30, 2017. Olin undertakes no obligation to update publicly any forward-looking statements, whether as a result of future events, new information or otherwise.

## **Non-GAAP Financial Measures**

In addition to U.S. GAAP financial measures, this presentation includes certain non-GAAP financial measures including EBITDA and Adjusted EBITDA. These non-GAAP measures are in addition to, not a substitute for or superior to, measures for financial performance prepared in accordance with U.S. GAAP. Definitions of these measures and reconciliation of GAAP to non-GAAP measures are provided in the appendix to this presentation.

# Company Overview



Olin Corporation		
	3Q 2017 <sup>1</sup>	9Mo 2017
<b>Revenue:</b>	\$ 1,555	\$ 4,649
<b>Adjusted EBITDA:<sup>2</sup></b>	\$ 266	\$ 666

Chlor Alkali Products and Vinyls		
	3Q17	9Mo17
<b>Revenue:</b>	\$ 881	\$ 2,583
<b>Adj. EBITDA:</b>	\$ 237	\$ 588

Epoxy		
	3Q17	9Mo17
<b>Revenue:</b>	\$ 490	\$ 1,550
<b>Adj. EBITDA:</b>	\$ 23	\$ 59

Winchester		
	3Q17	9Mo17
<b>Revenue:</b>	\$ 184	\$ 516
<b>Adj. EBITDA:</b>	\$ 22	\$ 76

All financial data are for the three and nine months ended September 30, 2017. Data are presented in millions of U.S. dollars. Additional information is available at [www.olin.com](http://www.olin.com).

<sup>1</sup>: Chlor Alkali Products and Vinyls third quarter 2017 Adjusted EBITDA was reduced by \$24 million and Epoxy third quarter 2017 Adjusted EBITDA was reduced by \$18.7 million as a result of incremental costs to continue operations and unabsorbed fixed manufacturing costs and reduced profit from lost sales associated with Hurricane Harvey.

<sup>2</sup>: Olin's definition of "Adjusted EBITDA" (earnings before interest, taxes, depreciation and amortization) is net income (loss) plus an add-back for depreciation and amortization, interest expense (income), income tax expense (benefit), other expense (income), restructuring charges, acquisition-related costs and certain non-recurring items.

# Olin is a Global Leader in Chlorine Derivatives



## **Global:**

- **Top quartile chlor-alkali cost position**
- #1 chlor-alkali producer
- #1 seller of membrane grade caustic soda
- #1 supplier of epoxy materials
- #1 seller of chlorinated organic
- Broadest geographic presence in caustic, epoxy and chlorinated organics

## **North America:**

- **Most diversified chlorine envelope of any North America producer**
- #1 seller of chlorine
- #1 seller of industrial bleach
- #1 seller of on-purpose hydrochloric acid
- Full ownership of newest, world-scale membrane chlor-alkali facility
- The most extensive distribution and logistics network

# Significantly Expanded Chlorine End Uses

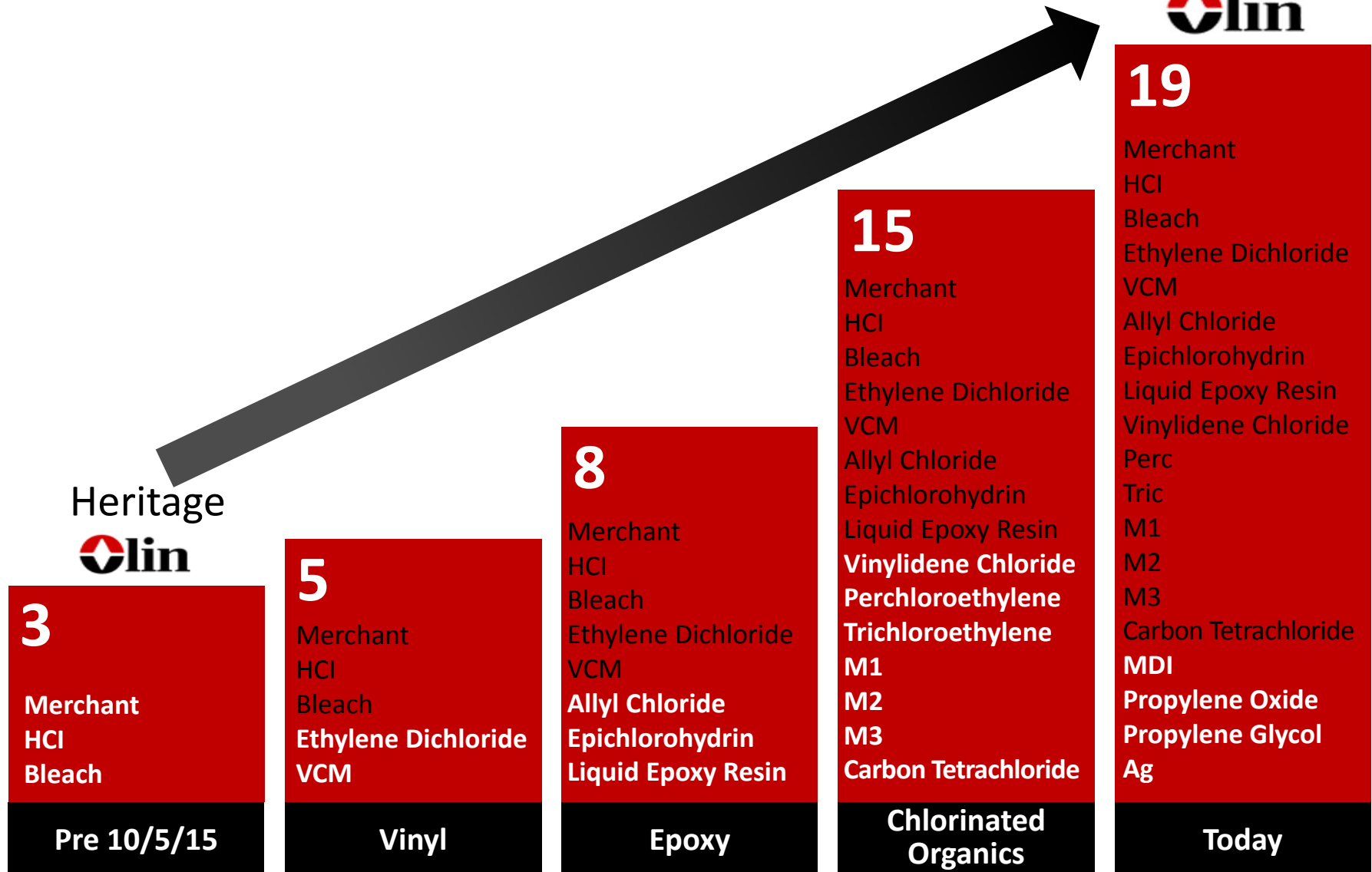

## Favorable Multi-Year View on Caustic Soda



**North American chlor alkali capacity reductions, no capacity additions expected in the next two to three years**

**European mercury cell chlor alkali production sunset by the end of this quarter**

**Increasing caustic exports from North America; 2017 volumes are forecast to increase 10% from 2016 record levels**

**Growing internal caustic soda consumption in China coupled with lower vinyls demand is limiting caustic soda exports from China**

**Global caustic soda demand growth is estimated to be between 1% and 2% annually**

# EDC Pricing History 2000 – 3Q 2017



## EDC Spot Export Prices

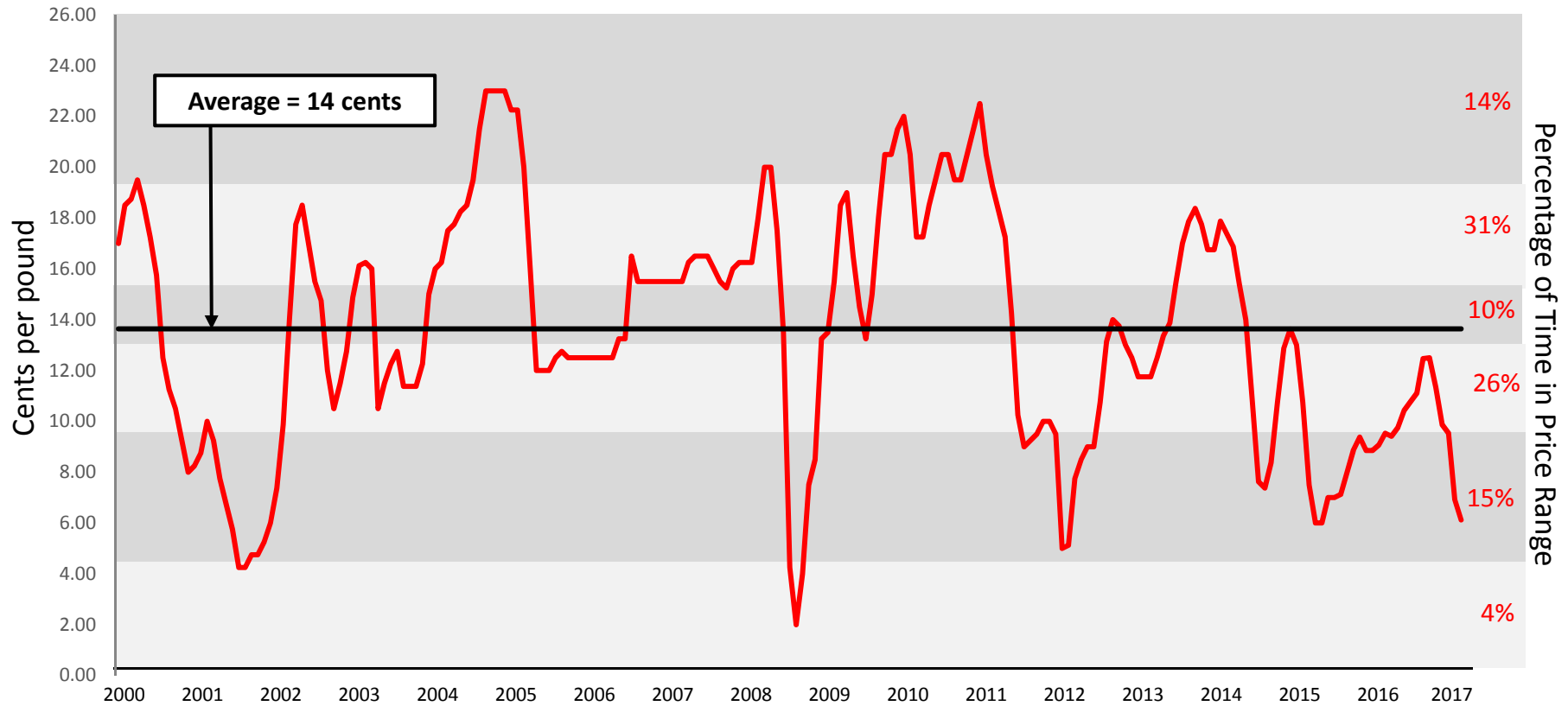

Source: IHS

- A \$0.01 change in Olin's EDC sales price changes annual Adjusted EBITDA by \$20 million
- Full year 2017 EDC pricing is forecast to improve by 10% from full year 2016 pricing

# Key Chlor Alkali Products & Vinyls EBITDA Sensitivity



Product	Price Change	Full Year EBITDA Impact
Chlorine	\$10/ton	\$10 million
Caustic Soda	\$10/ton	\$30 million
Ethylene Dichloride	\$.01/pound	\$20 million



# Epoxy has Access to Attractive High Growth End Uses Around the Globe



## Epoxy Resin Consumption<sup>1</sup>

(Tons in thousands)

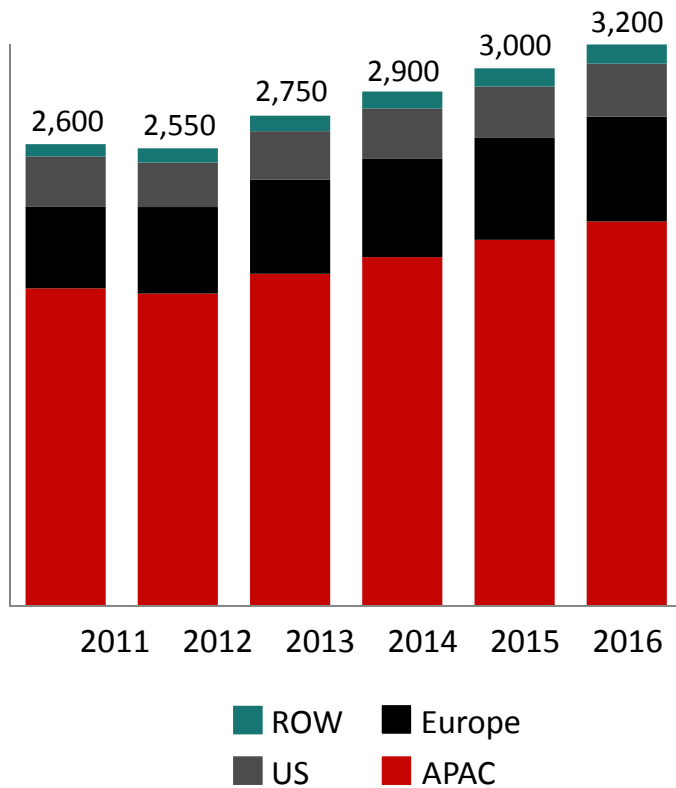

## CAGR ('13-'16)

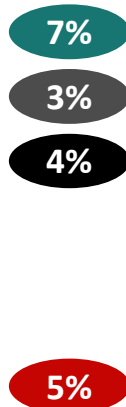

## Select Epoxy End Use Growth Rates('13-'18)<sup>2</sup>



Composites

8%



Electrical Laminates

5%



Industrial Coatings

4%



Civil Engineering, Adhesives

4%

Source: IHS Chemical Epoxy Resins CEH report  
 1: Liquid resins and Solid Epoxy Resins  
 2: Only includes US, Western Europe, Japan and China

# Epoxy Priorities for Success



	Upstream	Midstream	Downstream
<b>1</b> Continue driving productivity and cost improvements			
<b>2</b> Utilize advantaged cost position to outgrow the market ("Sell out")			
<b>3</b> Upgrade mix to improve margin ("Sell up")	N/A		

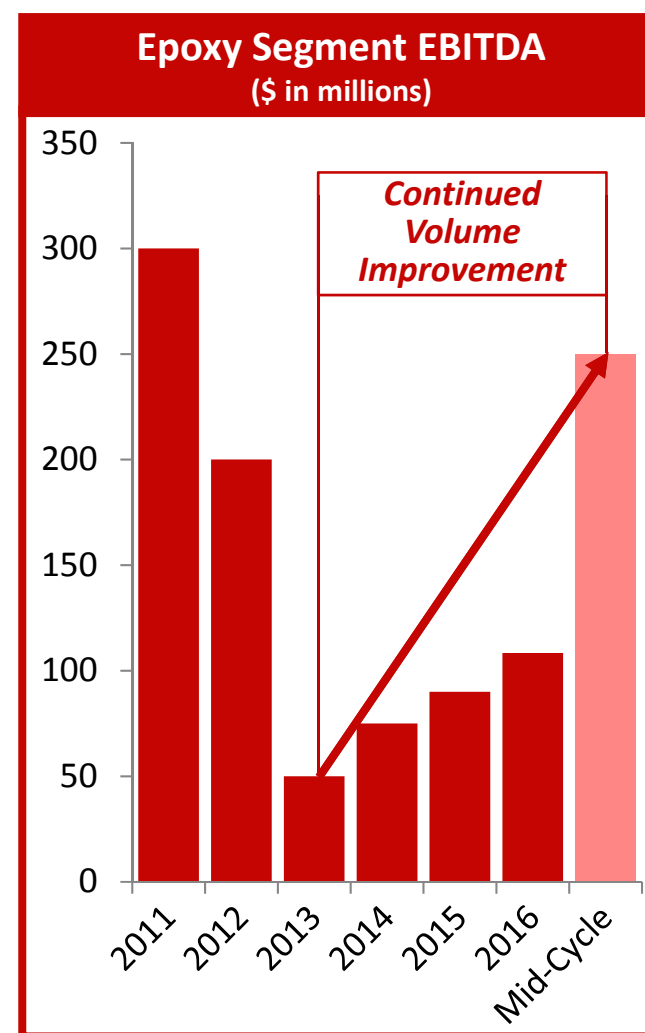

# Winchester



## Hunters & Recreational Shooters

Ammunition Products	Retail	Distributors	Mass Merchants	Law Enforcement	Military	Industrial
Rifle	✓	✓	✓	✓	✓	N/A
Handgun	✓	✓	✓	✓	✓	N/A
Rimfire	✓	✓	✓	✓	✓	✓
Shotshell	✓	✓	✓	✓	✓	✓
Components	✓	✓	✓	✓	✓	✓

### Brands:



# Favorable Ammunition Industry Trends



## Target Shooting Participation is Growing

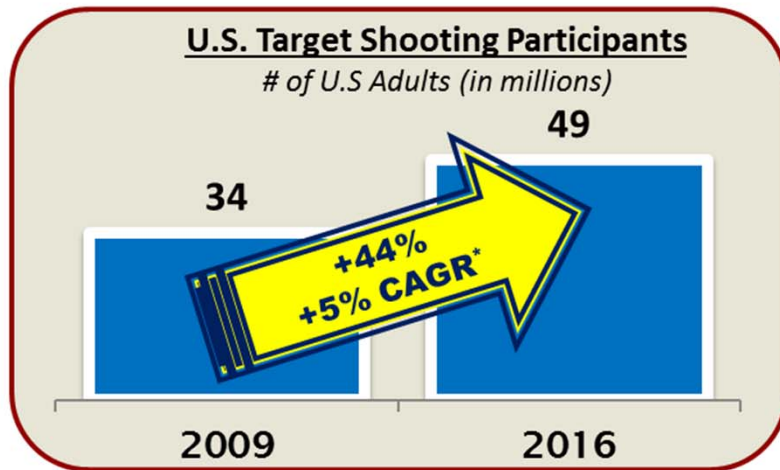

## New Shooters' Handgun Focus Continues to Grow

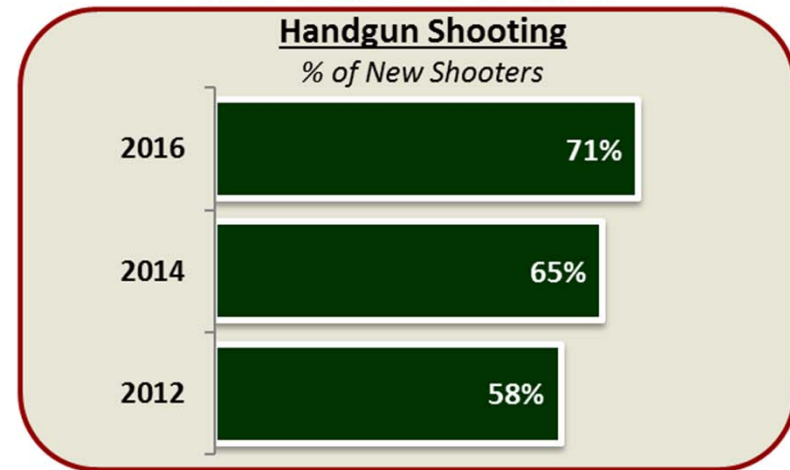

## Shooting Sports Industry is Attracting a Broader Demographic of Consumers

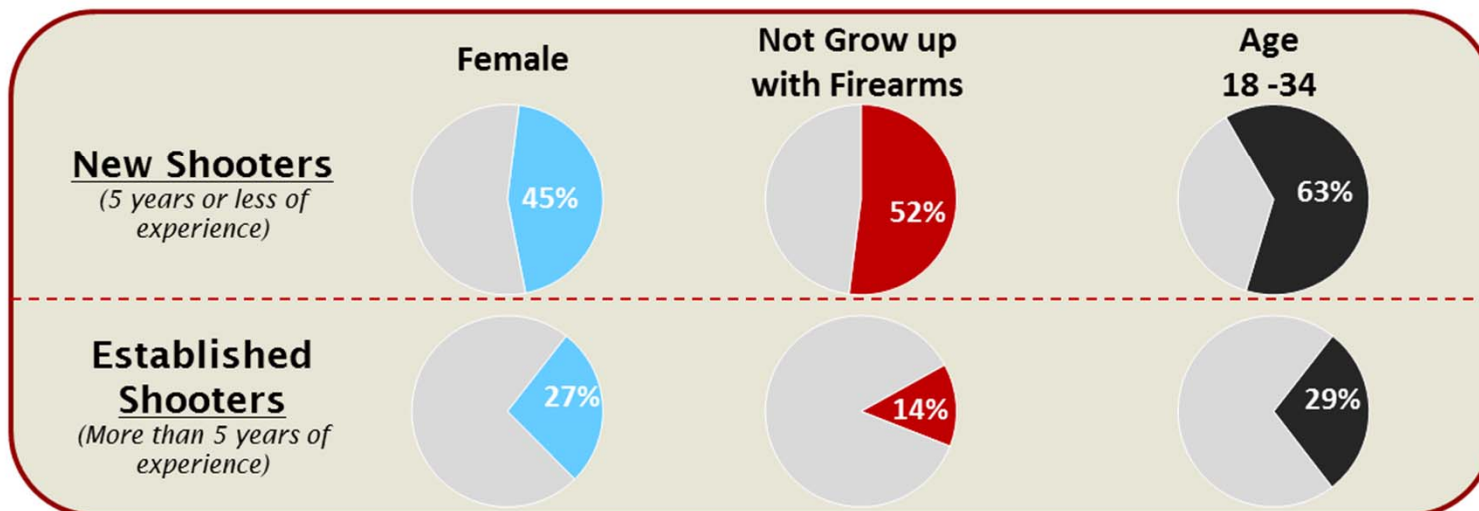



# Winchester Adjusted EBITDA Margins

(\$ in millions)

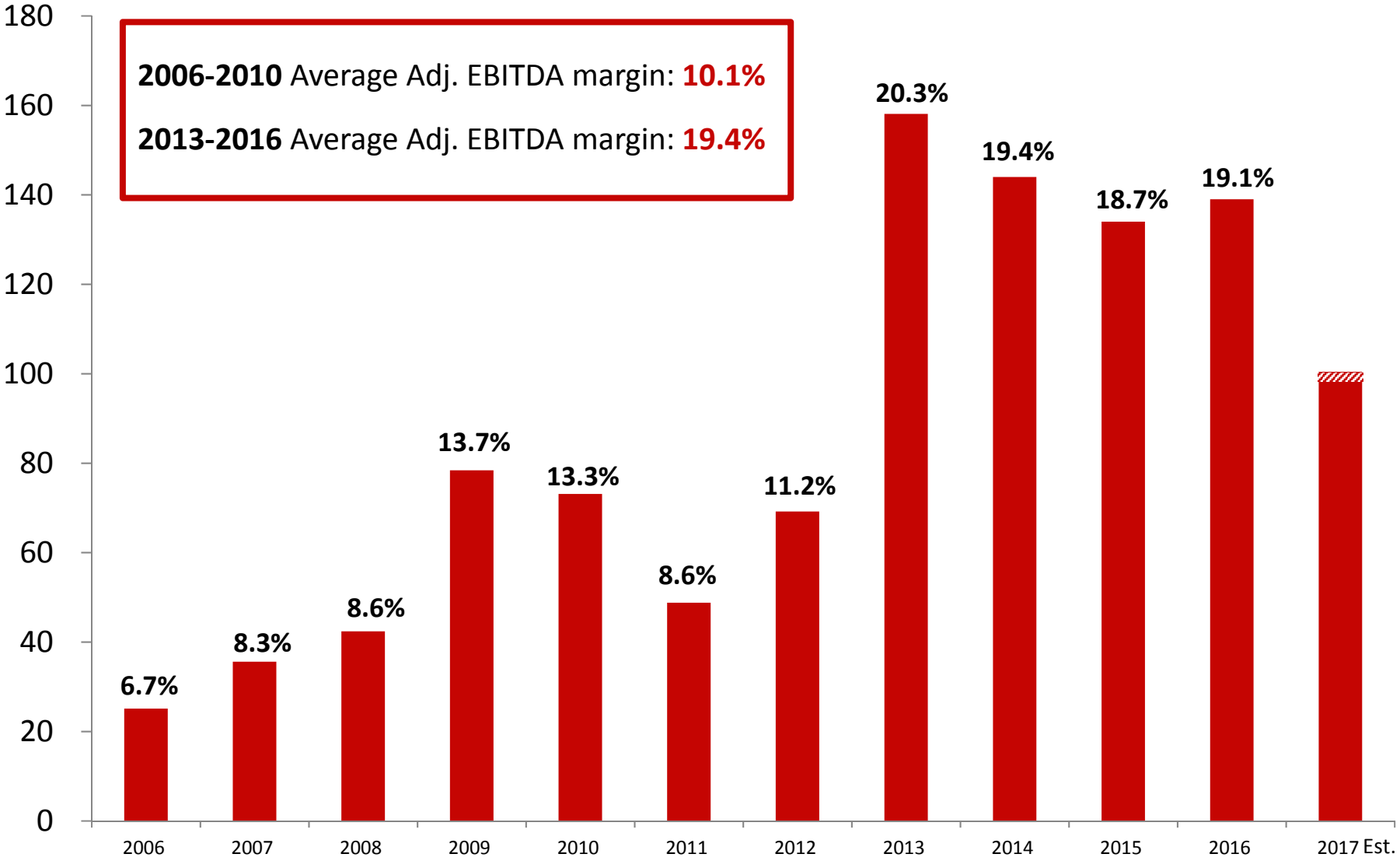

# 2017 Cash Flow Forecast



(\$ in millions)

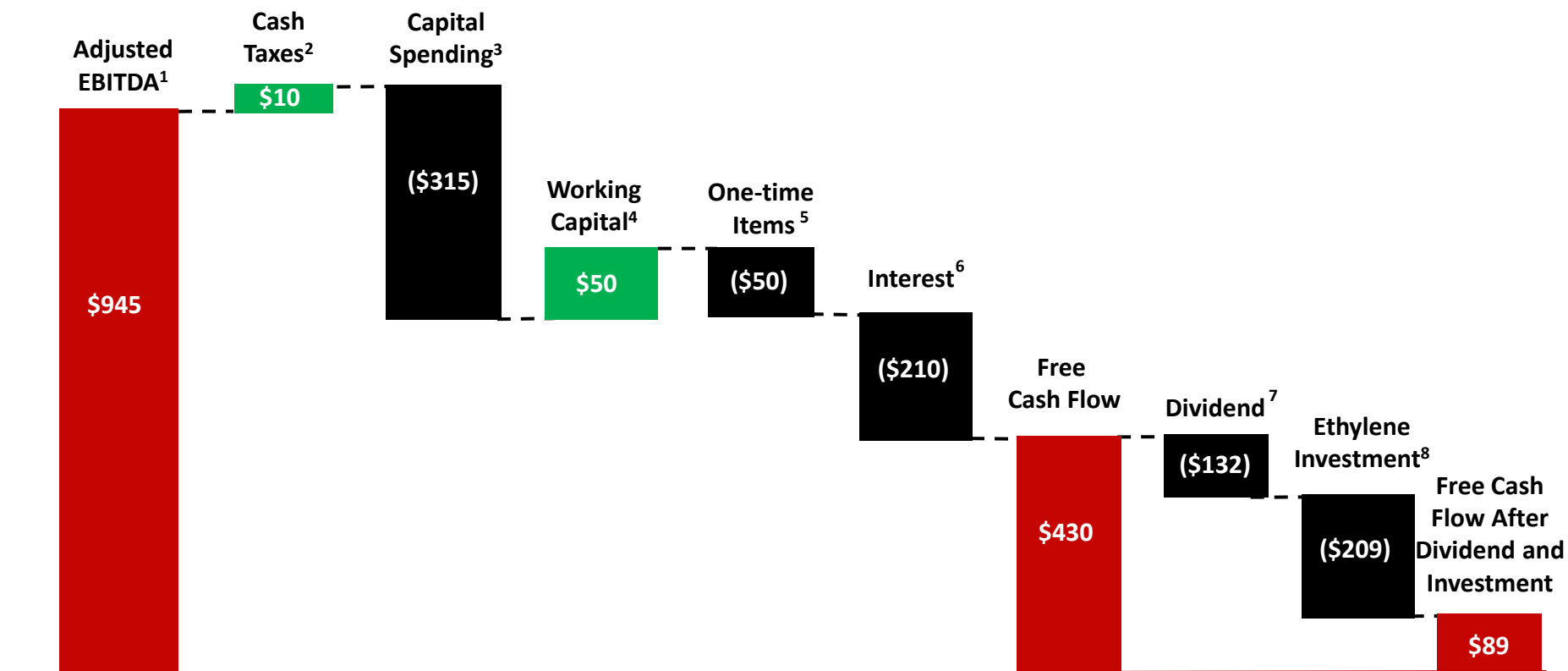

- 1: Mid-point of Olin's estimated Adjusted EBITDA forecast of \$945 million
- 2: Estimated using the mid-point of the cash tax rate of 20% to 25% and the benefits from the NOL carryforward and tax refunds
- 3: Represents the mid-point of management's annual capital spending estimate range of \$300 million to \$325 million
- 4: Net working capital reduction includes a program to accelerate the collection of \$50 million of receivables
- 5: One-time items include integration expenses and cash restructuring charges of \$50 million
- 6: Calculated based on Olin's capital structure, mandatory debt repayments and assuming current interest rates
- 7: Calculated based on 165 million shares outstanding and an annual dividend rate of \$0.80 per share
- 8: \$209 million investment to acquire additional ethylene supply at producer economics

## Adjusted EBITDA Potential: Mid-Cycle



**\$1.5 billion +**

Chlor-alkali Mid-Cycle

EDC Price Recovery

Continued Epoxy Improvement

Synergies

FY 2017 Forecast

**\$945 Million**

# Appendix





# The Chlorine Envelope

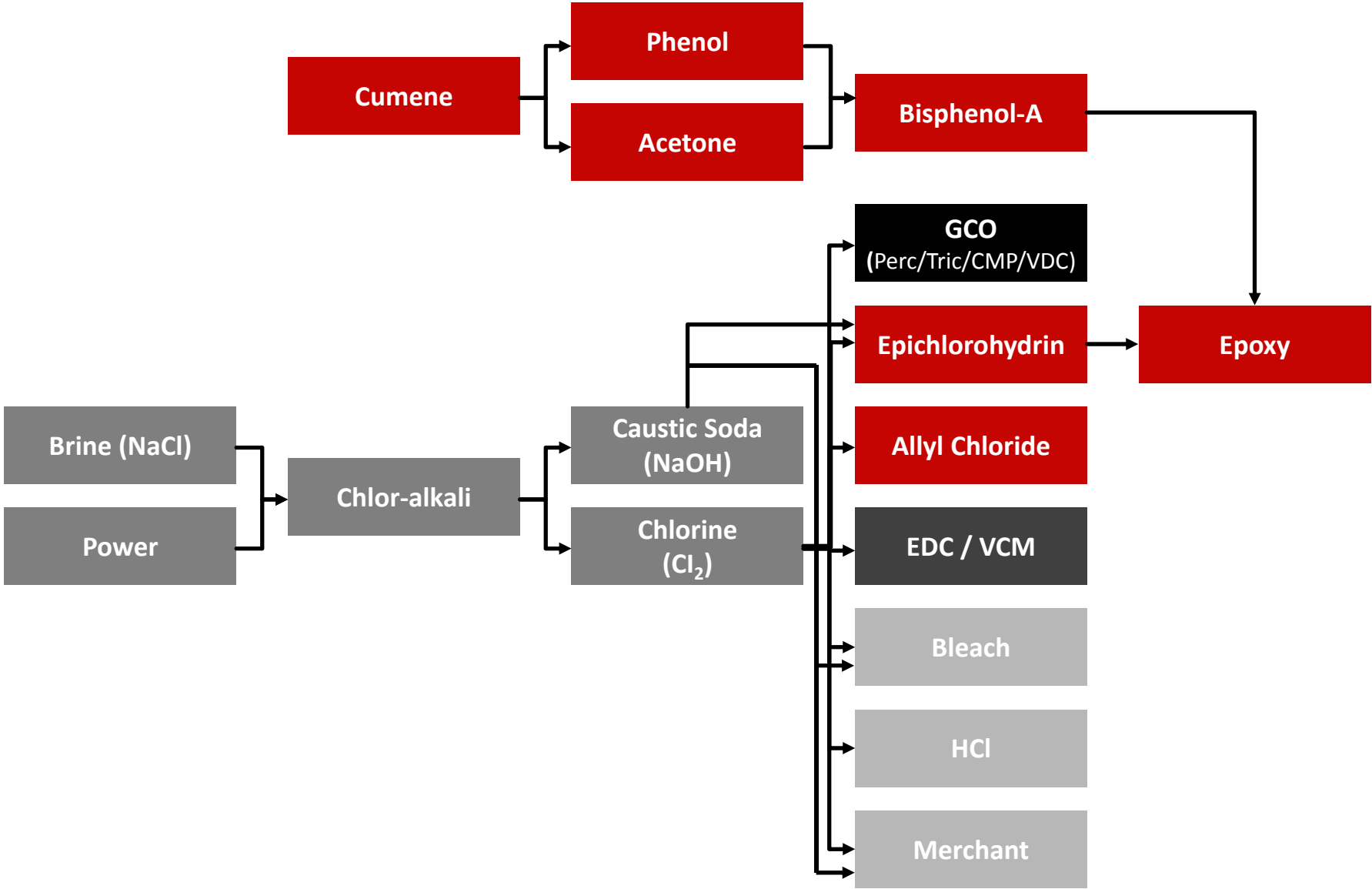



# Third Quarter 2017 Overview

---

**Adjusted EBITDA of \$265.5 million in the third quarter<sup>1</sup>**

**Impact of Hurricane Harvey on CAPV and Epoxy operations reduced third quarter Adjusted EBITDA by \$42.7 million**

**CAPV earnings included sequential improvement in caustic soda pricing**

**Epoxy segment improved sequentially as a result of higher pricing and lower raw material costs, primarily benzene and propylene**

**Winchester results impacted by continued lower commercial ammunition demand partially offset by higher military sales**

<sup>1</sup>: Third quarter net income is \$52.7 million

# Chlor Alkali Products and Vinyls Segment Performance



	3Q17	3Q16	Δ Q/Q
Sales	\$881.2	\$779.4	13.1%
Adjusted EBITDA	\$236.5	\$160.0	47.8%

(\$ in millions)

- 3Q17 Performance vs. 3Q16
  - Higher caustic soda pricing and lower EDC pricing
  - Impact of Hurricane Harvey of approximately \$24 million
  - Increased electricity costs and planned maintenance turnaround costs
- 4Q17 Outlook vs. 4Q16
  - Expect improvement in chlorine and caustic soda pricing, but lower EDC pricing
  - Expect lower ethylene costs due to ethylene investment in late September
  - Expect increase in electricity costs associated with higher natural gas prices

# Chlor Alkali Products and Vinyls Pricing and Volume Comparisons



## Volume Comparison \*

	3Q17 versus	
	3Q16	2Q17
Chlorine	↔	↓
Caustic Soda	↓	↙
EDC	↔	↓
Bleach	↗	↑
HCl	↑	↓
Chlorinated Organics	↔	↓

## Pricing Comparison

	3Q17 versus	
	3Q16	2Q17
Chlorine	↔	↔
Caustic Soda	↑	↑
EDC	↓	↓
Bleach	↗	↗
HCl	↑	↑
Chlorinated Organics	↑	↗

\* Note: Third quarter 2017 volumes impacted by Hurricane Harvey.

# Olin Caustic Soda Price Realization



## Fundamental Principle

- A \$10 per ton change in Olin's caustic soda selling price changes annual Adjusted EBITDA by approximately \$30 million

## Export Sales

- Sold on a combination of negotiated sales and export index price
- Changes in export index prices are typically realized on a 30 to 90 day lag
- Realization of index price changes are typically 80% to 100%

## Domestic Sales

- A significant portion of domestic sales are linked to index prices
- Index price changes typically occur 30 to 90 days post our price nomination
- Depending on market conditions 30% to 70% of index price changes are realized
- Overall price realization lags index price changes by 30 to 120 days

# Epoxy Segment Performance



	3Q17	3Q16	Δ Q/Q
Sales	\$489.9	\$470.1	4.2%
Adjusted EBITDA	\$22.7	\$32.9	-31.0%

(\$ in millions)

- 3Q17 Performance vs. 3Q16
  - Higher product pricing
  - Higher raw materials costs associated with benzene and propylene
  - Impact of Hurricane Harvey of approximately \$19 million
- 4Q17 Outlook vs. 4Q16
  - Expect higher product pricing
  - Expect higher raw materials costs associated with benzene and propylene
  - Impacted by a 35-day planned maintenance turnaround in Stade, Germany and lingering effects of Hurricane Harvey

# Maintenance Turnaround Costs

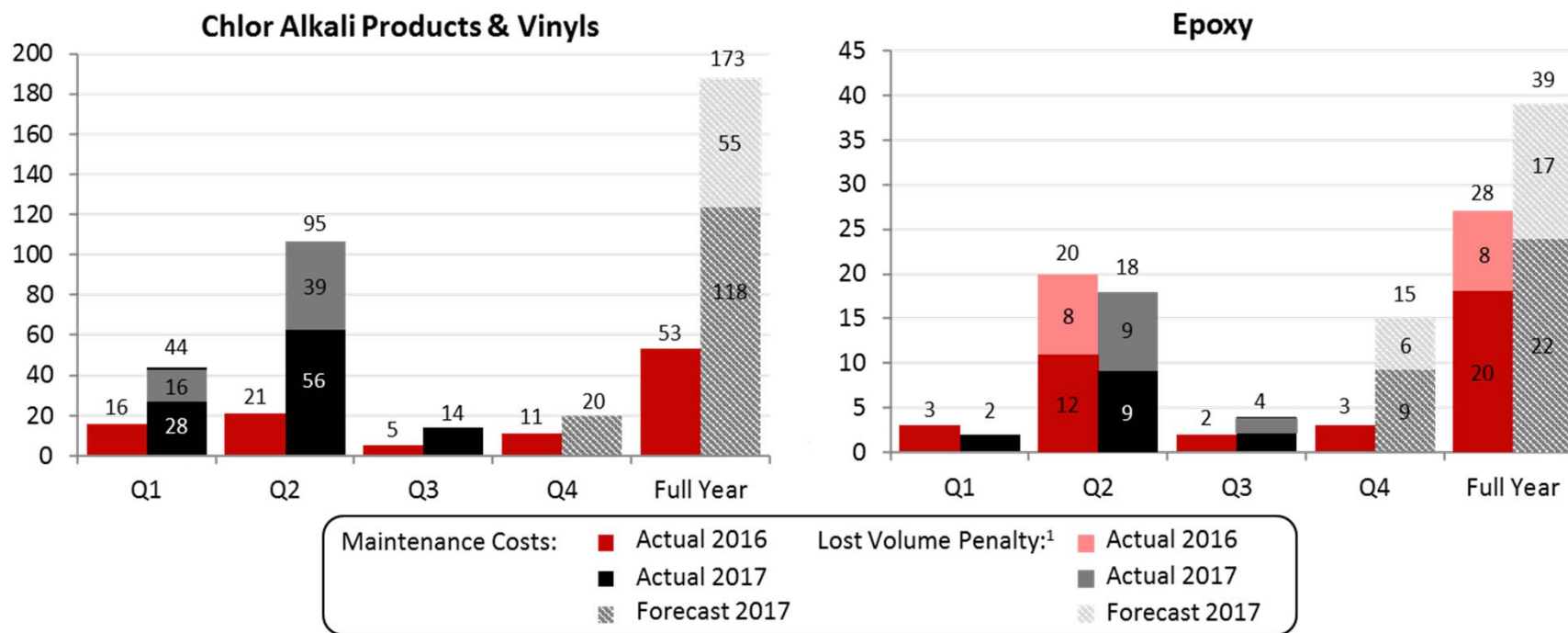

- Full year 2017 turnaround costs expected to be approximately \$130 million higher than 2016
- 2Q 2017 CAPV turnaround costs include VCM and Freeport, TX chlor alkali turnarounds
- 2Q 2017 Epoxy turnaround costs include 21-day unplanned Bisphenol-A outage in Freeport, TX
- 3Q 2017 and 4Q 2017 costs exclude costs related to the impact of Hurricane Harvey
- 4Q 2017 includes a 35-day planned Epoxy turnaround

<sup>1</sup>: Lost volume penalty includes unabsorbed fixed manufacturing costs and reduced pretax profit from lost sales associated with the turnarounds and outages

# Winchester Segment Performance



	3Q17	3Q16	Δ Q/Q
Sales	\$183.8	\$203.2	-9.5%
Adjusted EBITDA	\$22.0	\$40.7	-45.9%

(\$ in millions)

- 3Q17 Performance vs. 3Q16
  - Lower volumes to commercial customers
  - Less favorable product mix and higher commodity and material costs
  - Higher sales to military customers
- 4Q17 Outlook vs. 4Q16
  - Expect lower commercial sales
  - Expect higher sales to military customers
  - Expect higher commodity and other material costs



# Significant Realizable Synergies



(\$ in millions)

	Actual 2016	Synergies Breakdown	2017	2018	2019
Logistics & Procurement	75	Projected Annual Impact	125-150	180-200	250
Operational Efficiencies	120	Projected Year-End Run Rate	150-175	230-250	250
Asset Optimization					
Accessing New Segments & Customers	6	Projected Annual Impact	15-25	40-50	100
	10	Projected Year-End Run Rate	35-50	50	100
Capital Investment	205	Projected CAPEX and Investments	30	20	0
	70	Projected Cash Integration & Restructuring Costs	35	35	20

## Advantaged Ethylene Arrangement



- A series of three supply agreements with Dow
- Pipeline supply without operating or start-up risk
- Producer economics for 20 years for each tranche

Tranche	Effective Date	Annual Volume (short-tons)	Cost (millions)
#1	Acquired at closing	Up to 180,000	\$433*
#2	Late September 2017	Up to 160,000	\$209
#3	Available ~ 4Q 2020	Up to 300,000	\$440-\$465

\* Includes option payments for Tranches #2 and #3; all options to obtain future cost-based ethylene have been exercised

# Full Year 2017 Adjusted EBITDA



## The 2017 forecast reflects the following:

- Higher domestic and export caustic soda pricing compared to 2016;
- Improved EDC pricing of approximately 10% year-over-year;
- Incremental cost synergy realizations of approximately \$50 million to \$75 million;
- Epoxy segment results slightly lower than full year 2016;
- Higher electricity costs, primarily driven by higher natural gas costs versus 2016;
- Higher planned maintenance turnaround costs of approximately \$130 million as compared to 2016;
- Impact of Hurricane Harvey of approximately \$53 million to \$58 million; and
- Lower Winchester segment results due to lower commercial ammunition demand, a less favorable product mix, lower product pricing and higher commodity and material costs.

# Full Year Forecast Assumptions



	Full Year 2017 Forecast	Key Elements
<b>(\$ in millions)</b>		
Capital Spending	\$300 to \$325	Maintenance level of capital spending of \$225M to \$275M annually, system implementation spending of \$40M, and synergy capital of \$35M, includes bleach capacity, and other projects
Investments	\$209	Includes 20 year ethylene at cost supply contract
Depreciation & Amortization	\$545 to \$555	Property, plant and equipment and intangible assets fair value step up of approximately \$2.5B. Includes FV step up of \$160M
Pension Income	\$40 to \$45	Lower than 2016 income levels by approximately \$10M
Environmental Expense	\$8 to \$10	Represents a more historic level of expense
Other Corporate & Unallocated Costs	\$110 to \$115	Stock-based compensation, legal and litigation costs, and the build out of corporate infrastructure costs
Restructuring & Acquisition Costs	\$50	Acquisition related integration and restructuring costs
Book Effective Tax Rate	20% to 25%	Favorable book/tax permanent differences, primarily salt depletion
Cash Tax Rate	\$10 Refund	2017 cash tax benefit utilizes the benefits of NOL carry forwards from 2015, 2016 and income tax refunds

# Non-GAAP Financial Measures – Adjusted EBITDA <sup>(a)</sup>



Olin's definition of Adjusted EBITDA (Earnings before interest, taxes, depreciation, and amortization) is net income (loss) plus an add-back for depreciation and amortization, interest expense (income), income tax expense (benefit), other expense (income), restructuring charges, acquisition-related costs and certain other non-recurring items. Adjusted EBITDA is a non-GAAP financial measure. Management believes that this measure is meaningful to investors as a supplemental financial measure to assess the financial performance of our assets without regard to financing methods, capital structures, taxes or historical cost basis. The use of non-GAAP financial measures is not intended to replace any measures of performance determined in accordance with GAAP and Adjusted EBITDA presented may not be comparable to similarly titled measures of other companies. Reconciliation of forward-looking non-GAAP financial measures to the most directly comparable GAAP financial measures are omitted from this release because Olin is unable to provide such reconciliations without the use of unreasonable efforts. This inability results from the inherent difficulty in forecasting generally and quantifying certain projected amounts that are necessary for such reconciliations. In particular, sufficient information is not available to calculate certain adjustments required for such reconciliations, including interest expense (income), income tax expense (benefit), other expense (income), restructuring charges and acquisition-related costs. Because of our inability to calculate such adjustments, forward-looking net income guidance is also omitted from this release. We expect these adjustments to have a potentially significant impact on our future GAAP financial results.

(In millions)	Three Months		Nine Months	
	Ended September 30, 2017	2016	Ended September 30, 2017	2016
<b>Reconciliation of Net Income (Loss) to Adjusted EBITDA:</b>				
Net Income (Loss)	\$ 52.7	\$ 17.5	\$ 60.2	\$ (21.4)
<b>Add Back:</b>				
Interest Expense	53.1	47.5	158.0	143.6
Interest Income	(0.4)	(0.5)	(1.0)	(1.3)
Income Tax Provision (Benefit)	7.7	3.8	(3.7)	(36.3)
Depreciation and Amortization	139.2	135.3	411.4	397.4
<b>EBITDA</b>	<b>252.3</b>	<b>203.6</b>	<b>624.9</b>	<b>482.0</b>
<b>Add Back:</b>				
Restructuring Charges (b)	9.2	5.2	25.9	106.2
Acquisition-related Costs (c)	1.1	13.1	12.5	39.6
Information Technology Integration Project (d)	2.9	-	2.9	-
Certain Non-recurring Items (e)	-	-	-	(11.0)
<b>Adjusted EBITDA</b>	<b>\$ 265.5</b>	<b>\$ 221.9</b>	<b>\$ 666.2</b>	<b>\$ 616.8</b>

(a) Unaudited.

(b) Restructuring charges for the three and nine months ended September 30, 2017 and 2016 were primarily associated with the closure of 433,000 tons of chlor alkali capacity across three separate Olin locations. For the nine months ended September 30, 2016, \$76.6 million of these charges were non-cash impairment charges for equipment and facilities.

(c) Acquisition-related costs for the three and nine months ended September 30, 2017 and 2016 were associated with our integration of the Acquired Business.

(d) Information technology integration project for both the three and nine months ended September 30, 2017 included costs associated with the implementation of new enterprise resource planning, manufacturing, and engineering systems, and related infrastructure costs.

(e) Certain non-recurring items for the nine months ended September 30, 2016 included an \$11.0 million insurance recovery for property damage and business interruption related to a 2008 chlor alkali facility incident.

# Non-GAAP Financial Measures by Segment



	Three Months Ended September 30, 2017			Three Months Ended September 30, 2016		
(In millions)	Income (loss) before Taxes	Depreciation and Amortization	Adjusted EBITDA	Income (loss) before Taxes	Depreciation and Amortization	Adjusted EBITDA
Chlor Alkali Products and Vinyls	\$ 129.7	\$ 106.8	\$ 236.5	\$ 53.7	\$ 106.3	\$ 160.0
Epoxy	(1.7)	24.4	22.7	10.3	22.6	32.9
Winchester	17.2	4.8	22.0	36.0	4.7	40.7

	Nine Months Ended September 30, 2017			Nine Months Ended September 30, 2016		
(In millions)	Income (loss) before Taxes	Depreciation and Amortization	Adjusted EBITDA	Income (loss) before Taxes	Depreciation and Amortization	Adjusted EBITDA
Chlor Alkali Products and Vinyls	\$ 270.0	\$ 318.0	\$ 588.0	\$ 152.5	\$ 311.6	\$ 464.1
Epoxy	(11.0)	69.6	58.6	18.5	67.3	85.8
Winchester	61.3	14.2	75.5	95.9	13.8	109.7