



Credit Suisse Basic Materials Conference

*New York, NY
September 12, 2018*



Forward-Looking Statements



This communication includes forward-looking statements within the meaning of the Private Securities Litigation Reform Act of 1995. These statements relate to analyses and other information that are based on management's beliefs, certain assumptions made by management, forecasts of future results, and current expectations, estimates and projections about the markets and economy in which we and our various segments operate. The statements contained in this presentation that are not statements of historical fact may include forward-looking statements that involve a number of risks and uncertainties.

We have used the words "anticipate," "intend," "may," "expect," "believe," "should," "plan," "project," "estimate," "forecast," "optimistic," and variations of such words and similar expressions in this presentation to identify such forward-looking statements. These statements are not guarantees of future performance and involve certain risks, uncertainties and assumptions, which are difficult to predict and many of which are beyond our control. Therefore, actual outcomes and results may differ materially from those matters expressed or implied in such forward-looking statements. All references to expectations and other forward-looking statements are based on expectations at July 31, 2018. Olin undertakes no obligation to update publicly any forward-looking statements, whether as a result of future events, new information or otherwise.

Factors that could cause or contribute to such differences include, but are not limited to: our sensitivity to economic, business and market conditions in the U.S. and overseas; the cyclical nature of our operating results and the supply/demand balance for our products; our reliance on a limited number of suppliers for specified feedstock and services, including third-party transportation services; higher-than-expected raw material and energy, transportation, and/or logistics costs; failure to control costs or to achieve targeted cost reductions; new regulations or public policy changes regarding the transportation of hazardous chemicals and the security of chemical manufacturing facilities; the occurrence of unexpected manufacturing interruptions and outages; complications resulting from our multiple enterprise resource planning systems and the conversion to one system; changes in, or failure to comply with, legislation or government regulations or policies; the failure or an interruption of our information technology systems; economic and industry downturns; declines in global equity markets and interest rates impacting pension plan asset values and liabilities; fluctuations in foreign currency exchange rates; unexpected litigation outcomes and environmental investigation and remediation costs; our substantial amount of indebtedness and debt service obligations; the integration of the DowDuPont Chemical Products Business not fully realizing the benefits of the anticipated synergies; the failure to attract, retain and motivate key employees; asset impairment charges resulting from the failure to realize our long range plan assumptions; adverse conditions in the credit and capital markets; and the other risks detailed in Olin's Form 10-K for the fiscal year ended December 31, 2017 and Olin's Form 10-Q for the quarter ended June 30, 2018. All of the forward-looking statements should be considered in light of these factors. In addition, other risks and uncertainties not presently known to Olin or that Olin considers immaterial could affect the accuracy of our forward-looking statements. The reader is cautioned not to rely unduly on these forward-looking statements.

Non-GAAP Financial Measures

In addition to U.S. GAAP financial measures, this presentation includes certain non-GAAP financial measures including EBITDA, and Adjusted EBITDA. These non-GAAP measures are in addition to, not a substitute for or superior to, measures for financial performance prepared in accordance with U.S. GAAP. Definitions of these measures and reconciliation of GAAP to non-GAAP measures are provided in the appendix to this presentation.

Company Overview



Olin Corporation		
	2Q18	1H18 ¹
Revenue:	\$ 1,728	\$ 3,439
Adjusted EBITDA:	\$ 325	\$ 566

Chlor Alkali Products and Vinyls		
	2Q18	1H18
Revenue:	\$1,019	\$1,955
Adj. EBITDA:	\$ 290	\$ 535

Epoxy		
	2Q18	1H18
Revenue:	\$ 544	\$ 1,147
Adj. EBITDA:	\$ 50	\$ 55

Winchester		
	2Q18	1H18
Revenue:	\$ 166	\$ 337
Adj. EBITDA:	\$ 17	\$ 34

All financial data are for the three months and six months ended June 30, 2018. Data are presented in millions of U.S. dollars. Additional information is available at www.olin.com.

¹: Olin's definition of "Adjusted EBITDA" (earnings before interest, taxes, depreciation and amortization) is net income (loss) plus an add-back for depreciation and amortization, interest expense (income), income tax expense (benefit), other expense (income), restructuring charges, acquisition-related costs and certain non-recurring items.

Highlights



**1. 2Q18 was highest quarterly Adjusted EBITDA of \$325 million;¹
Raising full year 2018 guidance by \$50 million to \$1.3 billion + / - 4%**

2. Maintenance turnarounds in 1H18 completed; expect lower costs of approximately \$135 million in 2H18, and \$30 to \$40 million lower in 2019 compared to 2018

3. Positive outlook for our Epoxy business; supply and demand dynamics constructive in the epoxy resins markets

4. Caustic soda pricing improved 5% sequentially in 2Q18; we expect domestic caustic soda pricing to improve in 3Q18; Multi-year positive caustic soda cycle intact

1: Second quarter net income is \$58.6 million.

Olin is a Global Leader in Chlorine Derivatives

Nineteen Chlorine Outlets



Global:

- **Top quartile chlor-alkali cost position**
- #1 chlor-alkali producer
- #1 seller of membrane grade caustic soda
- #1 supplier of epoxy materials
- #1 seller of chlorinated organic
- Broadest geographic presence in caustic, epoxy and chlorinated organics

North America:

- **Most diversified chlorine envelope of any North America producer**
- #1 seller of chlorine
- #1 seller of industrial bleach
- #1 seller of on-purpose hydrochloric acid
- Full ownership of newest, world-scale membrane chlor-alkali facility
- The most extensive distribution and logistics network

Favorable Chlor-Alkali Industry Conditions



- 1Q18 N.A. capacity reduction, no material chlor alkali plants coming on line in the next 2 to 3 years
- U.S. Chlorine production: June 2018 YTD 6.1 million tons, effective operating rate 89%
- Underlying macros remain strong, however, we have witnessed near-term dynamics in 2018 which have pressured prices in other regions
- Favorable caustic soda dynamics continue:
 - 2015-2017 U.S. exports increased 38% to 3.6 million tons, imports down 25% to 550,000 tons
 - 2015-2017 U.S. exports to Brazil increased 30% to 1.3 million tons
 - 2017 Chinese exports down 12% from 2015 levels to 850,000 tons

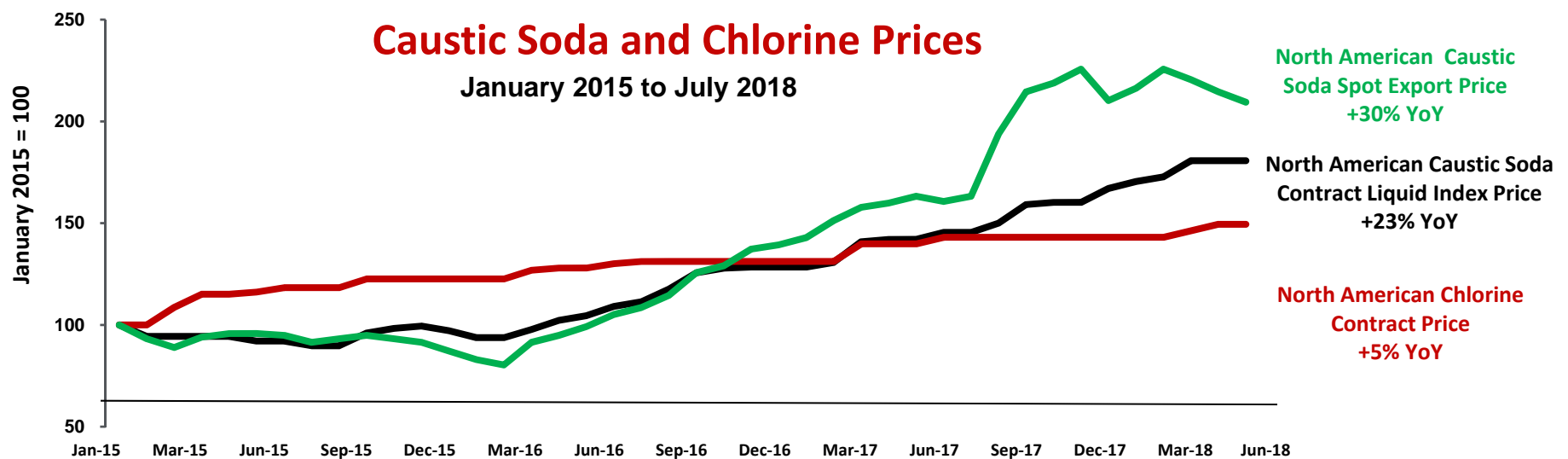

Source: IHS Markit / Tecnon

EDC Pricing History 2000 – June 2018

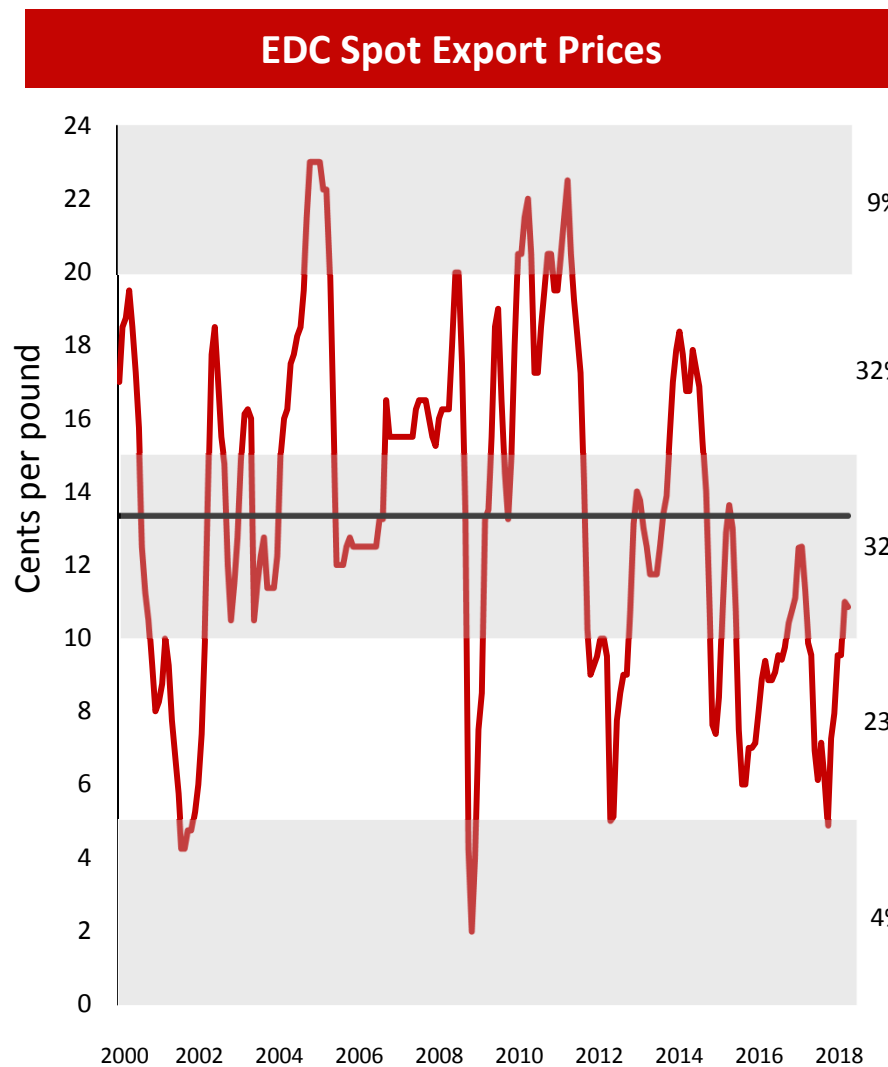

Source: IHS

- Pricing has recovered from the 5 year lows experienced in December 2017
- Improved supply / demand dynamic has enabled:
 - USGC pricing to improve in 2Q18 from 1Q18
 - USGC pricing is forecast to improve in 3Q18 from 2Q18
- Full year USGC pricing is forecast to improve in 2018 from 2017
- A 1 cent change in Olin's EDC sales price changes annual Adjusted EBITDA by \$20 million

Key Chlor Alkali Products & Vinyls EBITDA Sensitivity



Product	Price Change In Olin's System	Full Year EBITDA Impact
Chlorine	\$10/ton	\$10 million
Caustic Soda	\$10/ton	\$30 million
Ethylene Dichloride	\$.01/pound	\$20 million

Epoxy has Access to Attractive High Growth End Uses Around the Globe



Epoxy Resin Consumption

(Tons in thousands)

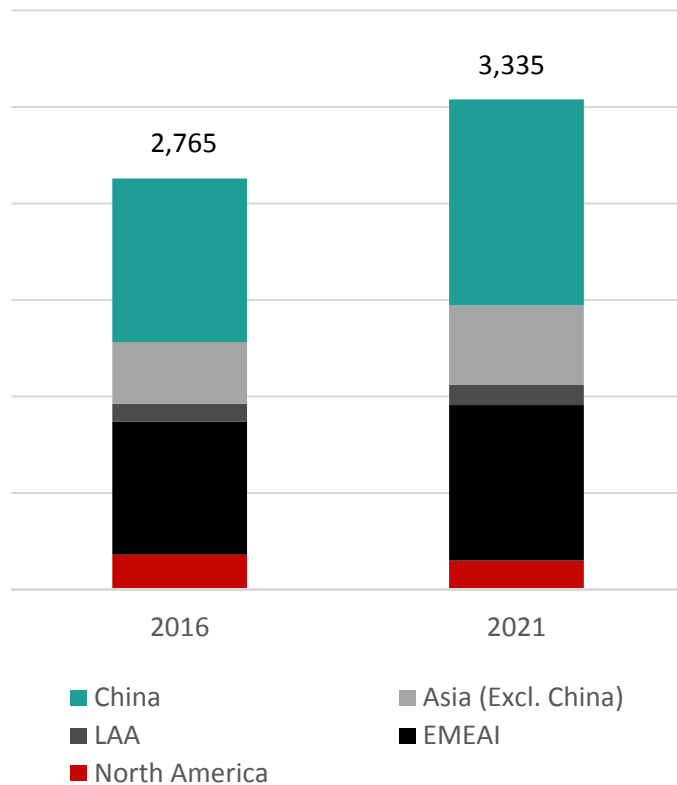

CAGR ('16-'21)

- 4.1%
- 2.7%
- 3.7%
- 4.7%
- 2.2%

Select Epoxy End Use Applications



Composites



Civil Engineering



Marine & Protective Coatings



Electrical Laminates

Source: IHS Markit Epoxy Resins Chemical Economics Handbook- Nov 2017

Liquid Epoxy Resin Pricing



- Positive supply and demand dynamics in the epoxy resin markets have continued
- Epoxy resin demand in North America improved 2Q18 from both 1Q18 and 2Q17
- Global resin demand growth is between 3% and 5%

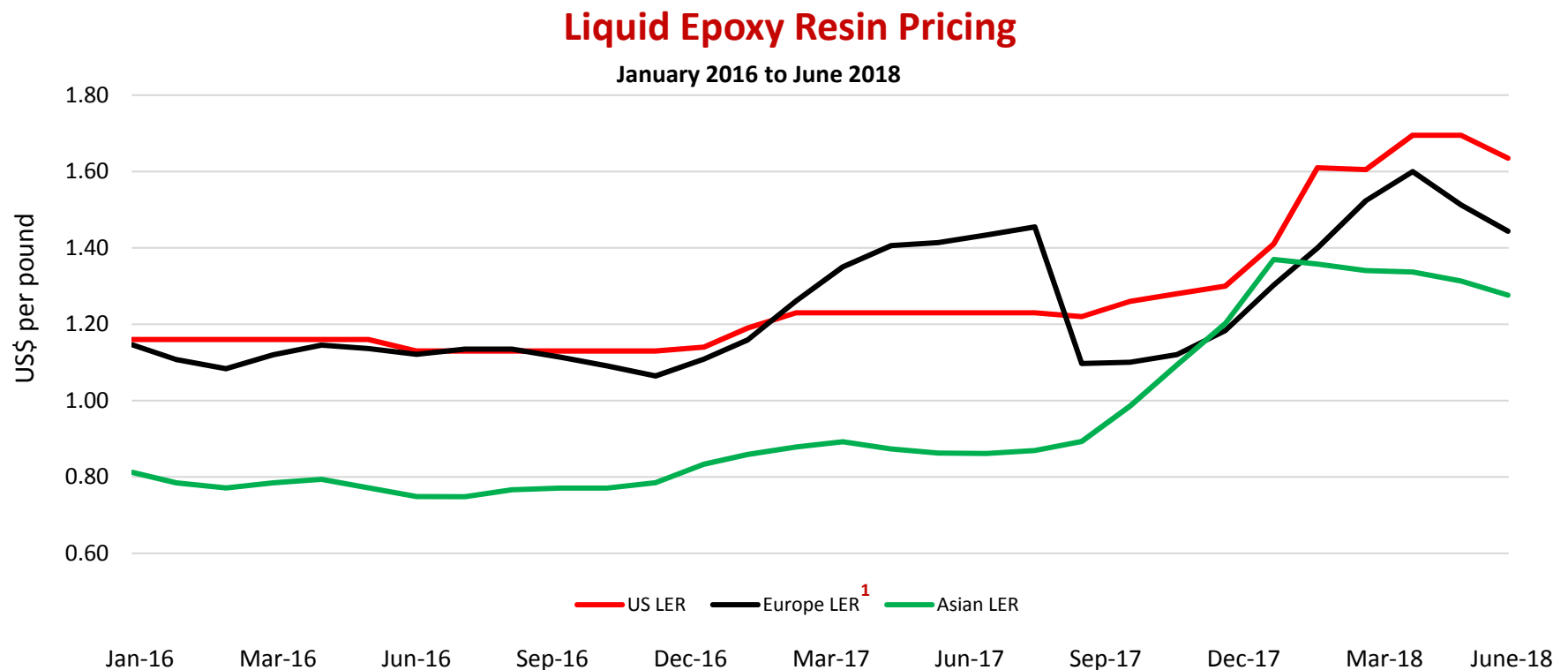

1. European liquid epoxy resin prices reflect a non-market adjustment made in the third quarter of 2017.

Source: ICIS

Epoxy Priorities for Success



	Upstream	Midstream	Downstream
1 Drive productivity to sustain cost advantage			
2 Focus on capturing the full value of our low-cost asset base ("Sell out")			N/A
3 Upgrade sales portfolio and product mix to improve margin ("Sell up")	N/A		

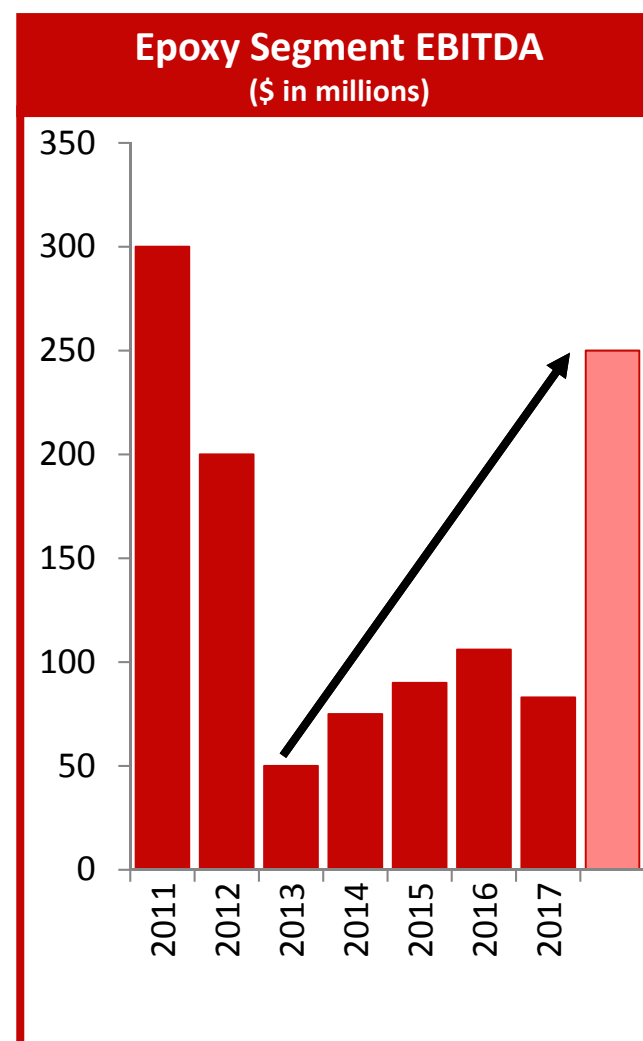

Winchester



Hunters & Recreational Shooters

Ammunition Products	Retail	Distributors	Mass Merchants	Law Enforcement	Military	Industrial
Rifle	✓	✓	✓	✓	✓	N/A
Handgun	✓	✓	✓	✓	✓	N/A
Rimfire	✓	✓	✓	✓	✓	✓
Shotshell	✓	✓	✓	✓	✓	✓
Components	✓	✓	✓	✓	✓	✓

Brands:





Winchester Adjusted EBITDA Margins

(\$ in millions)

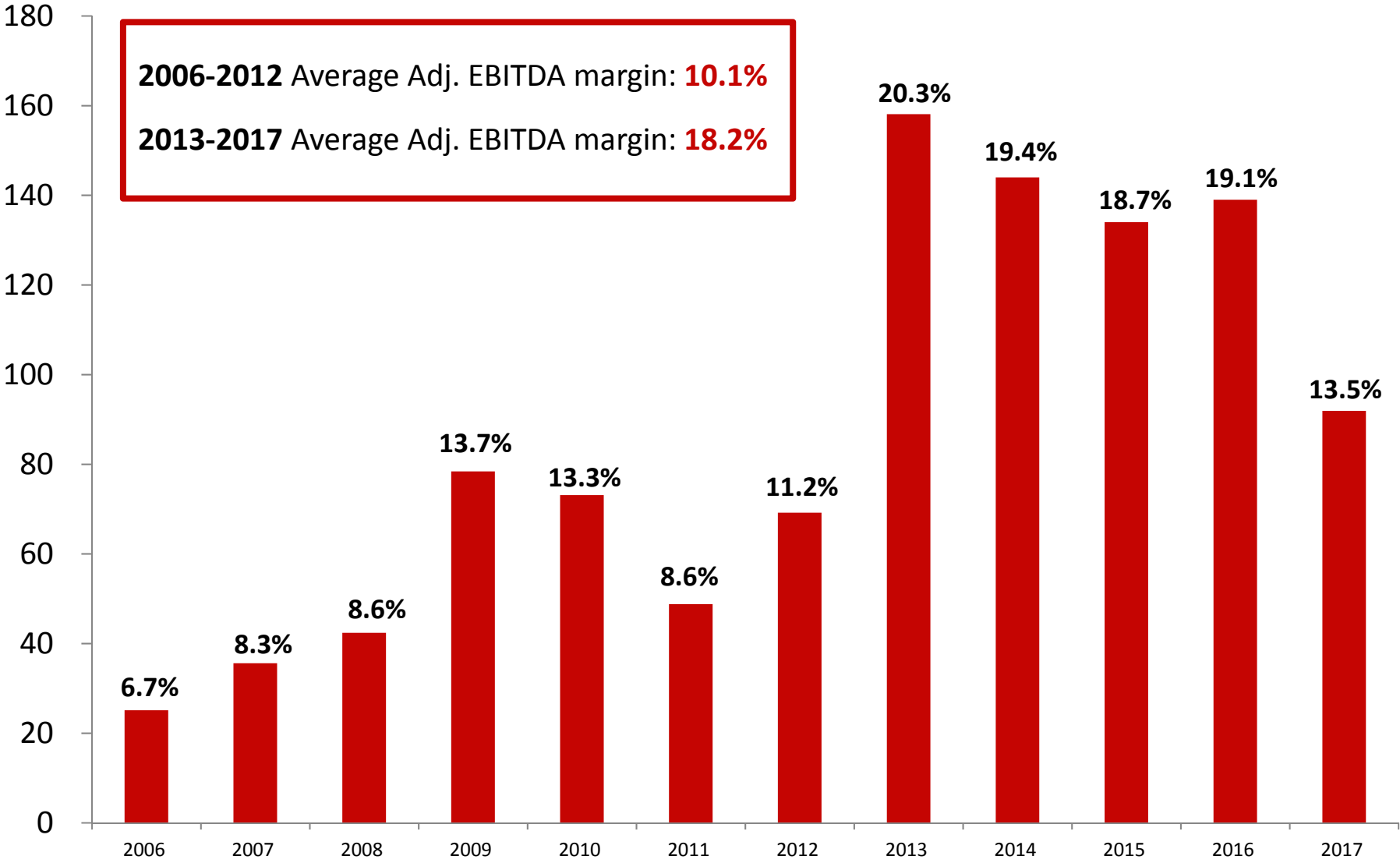



Full Year 2018 Adjusted EBITDA Forecast

(\$ in millions)

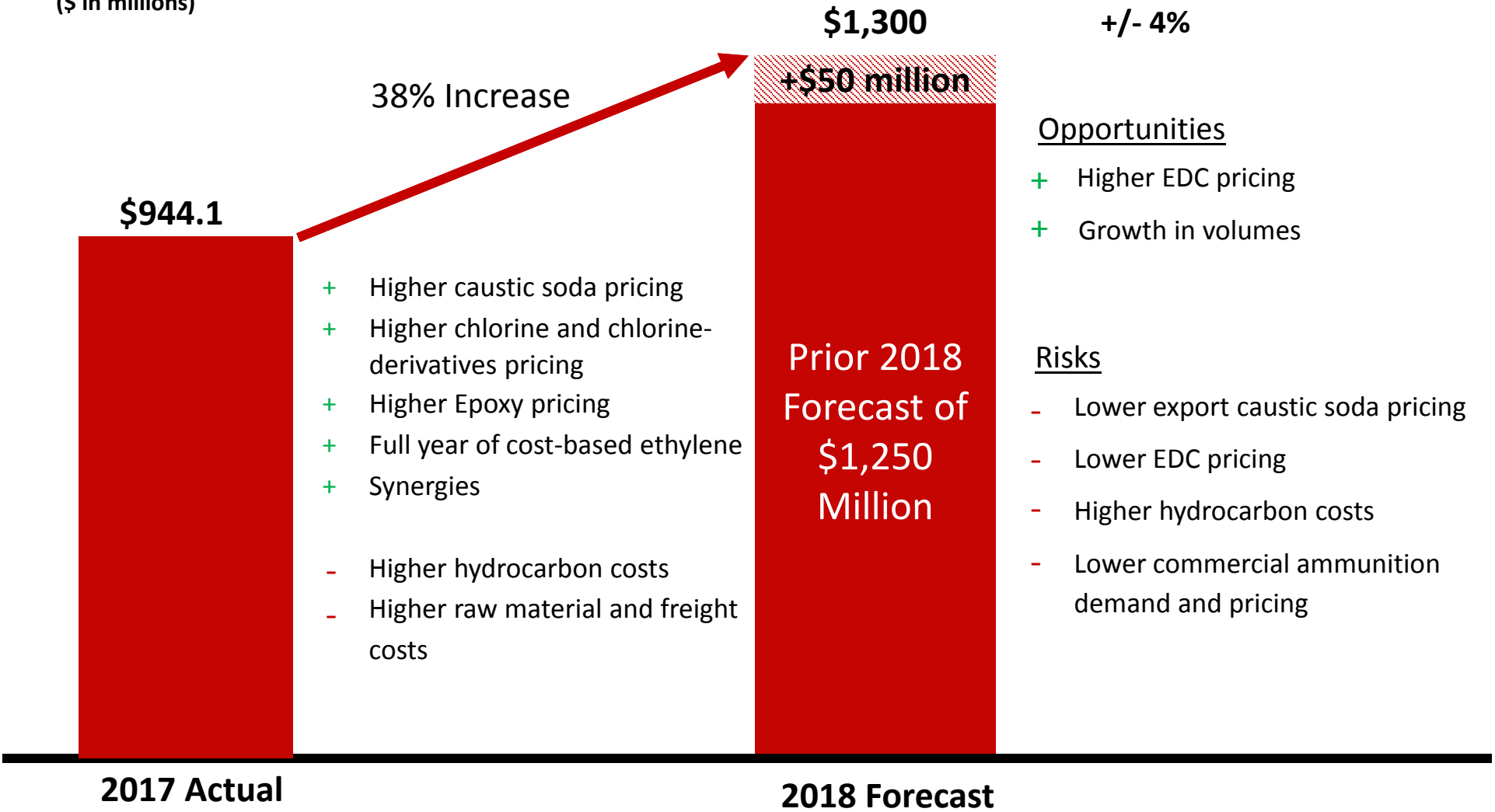

2018 Cash Flow Forecast

Debt Reduction Remains Top Priority for Free Cash Flow



(\$ in millions)

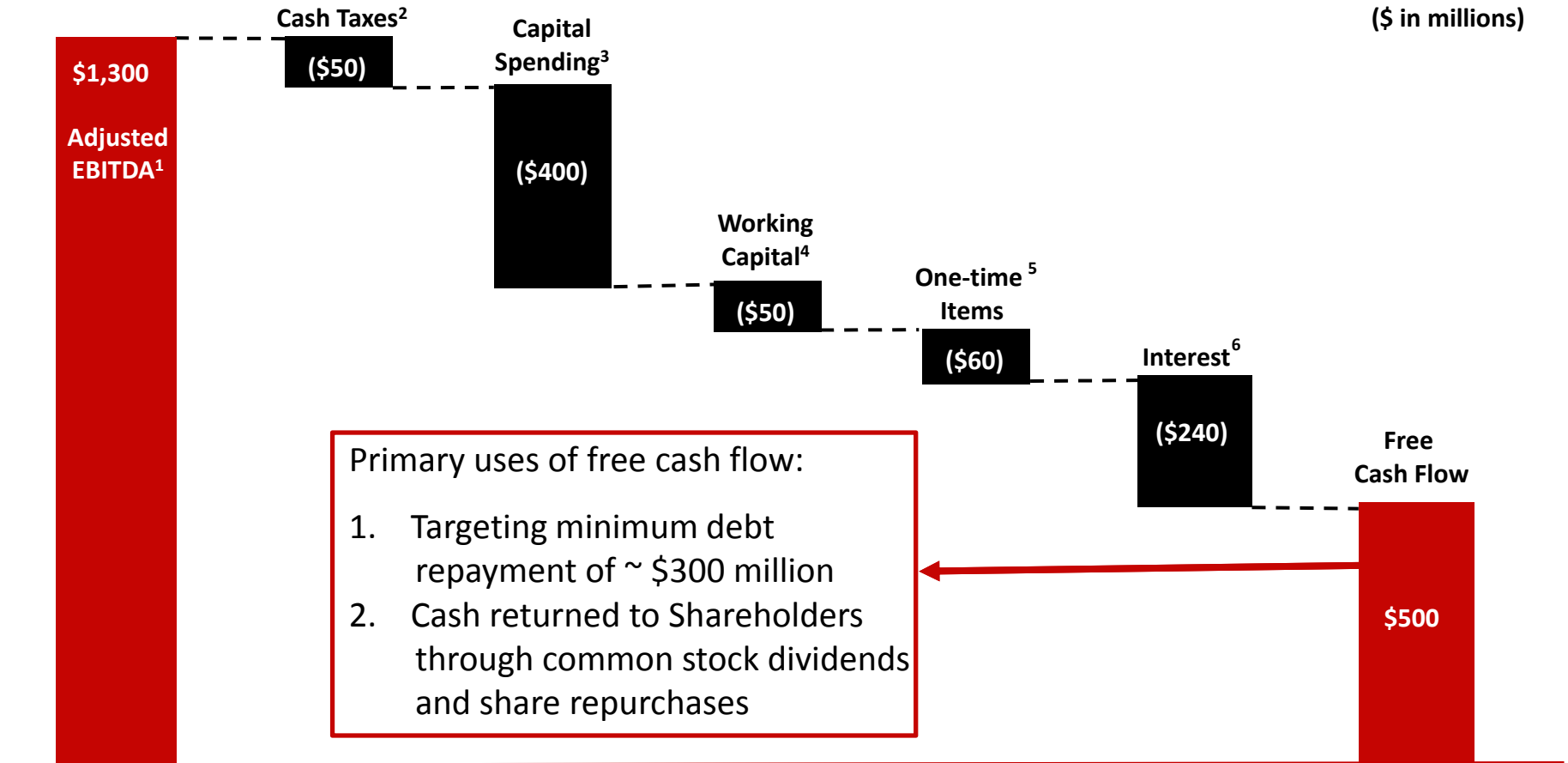

1: Mid-point of Olin's estimated Adjusted EBITDA forecast of \$1.3 billion plus or minus 4%. Includes pension income consistent with prior year's reporting

2: Estimated using the cash tax rate of 10% to 15%

3: Represents the mid-point of management's annual capital spending estimate range of \$375 million to \$425 million, which includes \$100 million associated with the information technology project

4: Estimated increase in working capital due to higher selling prices and hydrocarbon costs

5: One-time items include integration expenses, including the information technology project, cash restructuring charges, and an \$8.0 million insurance recovery

6: Calculated based on Olin's capital structure and assuming current interest rates

Near-Term Adjusted EBITDA Potential

(\$ in millions)

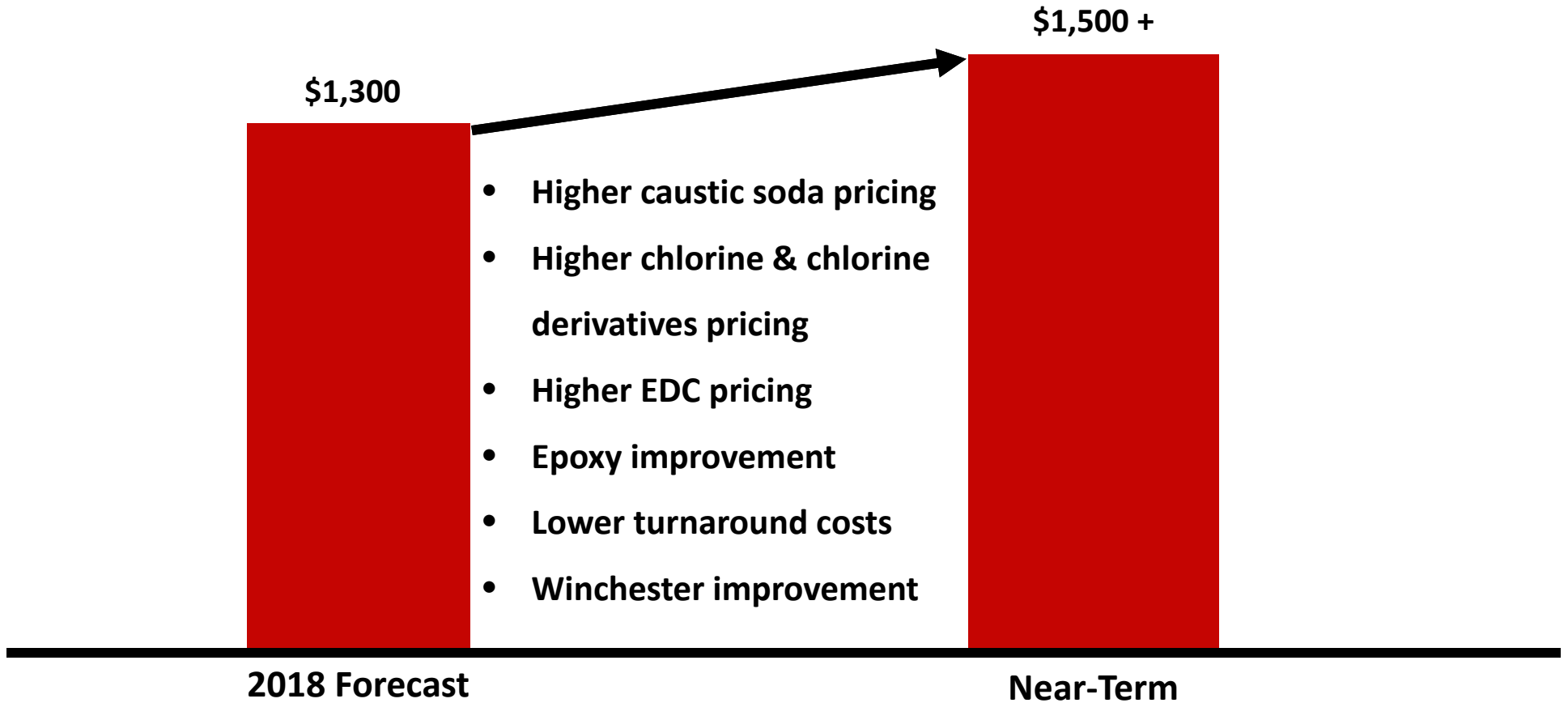

Appendix



The Chlorine Envelope

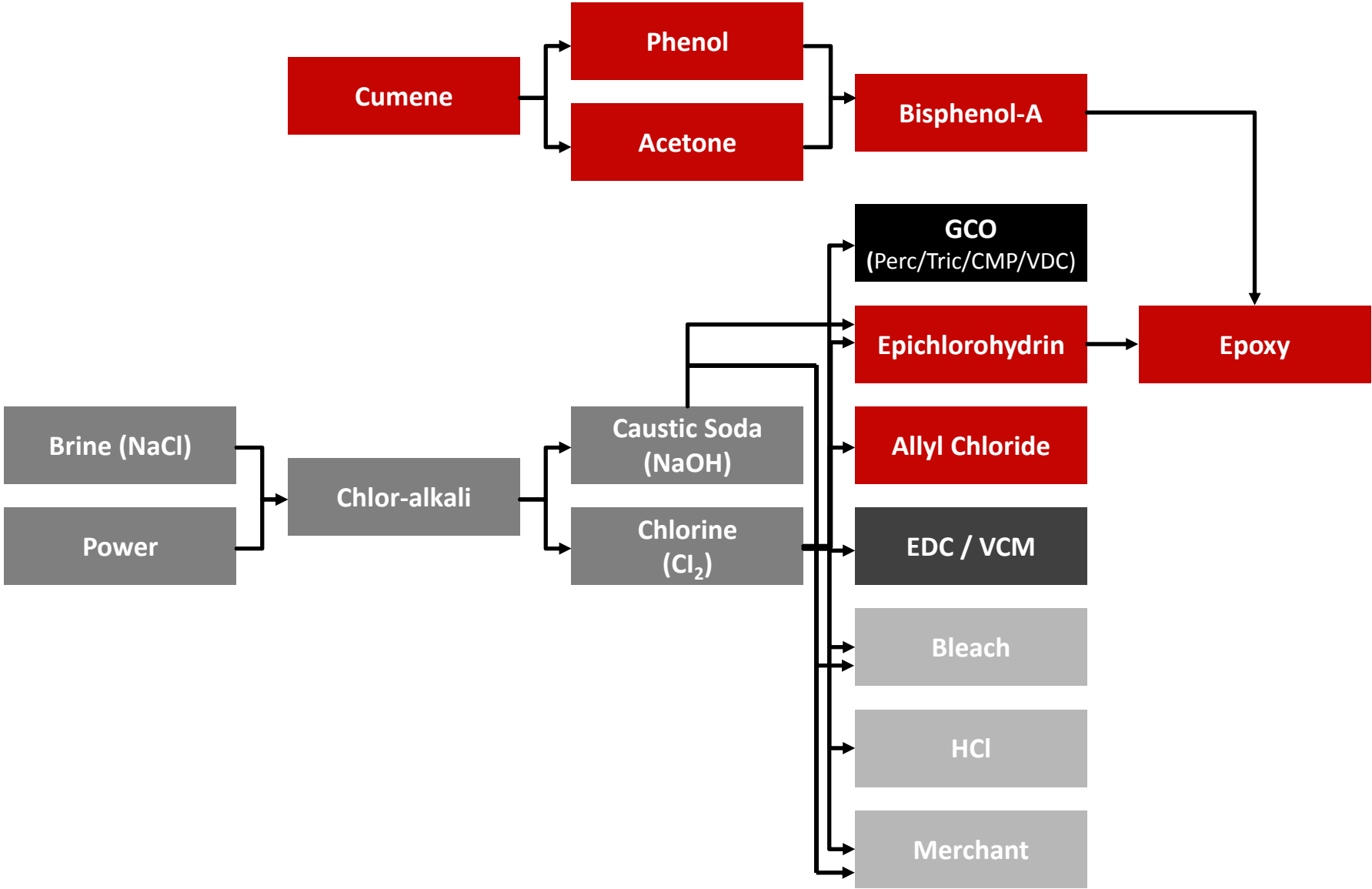

Significantly Expanded Chlorine End Uses

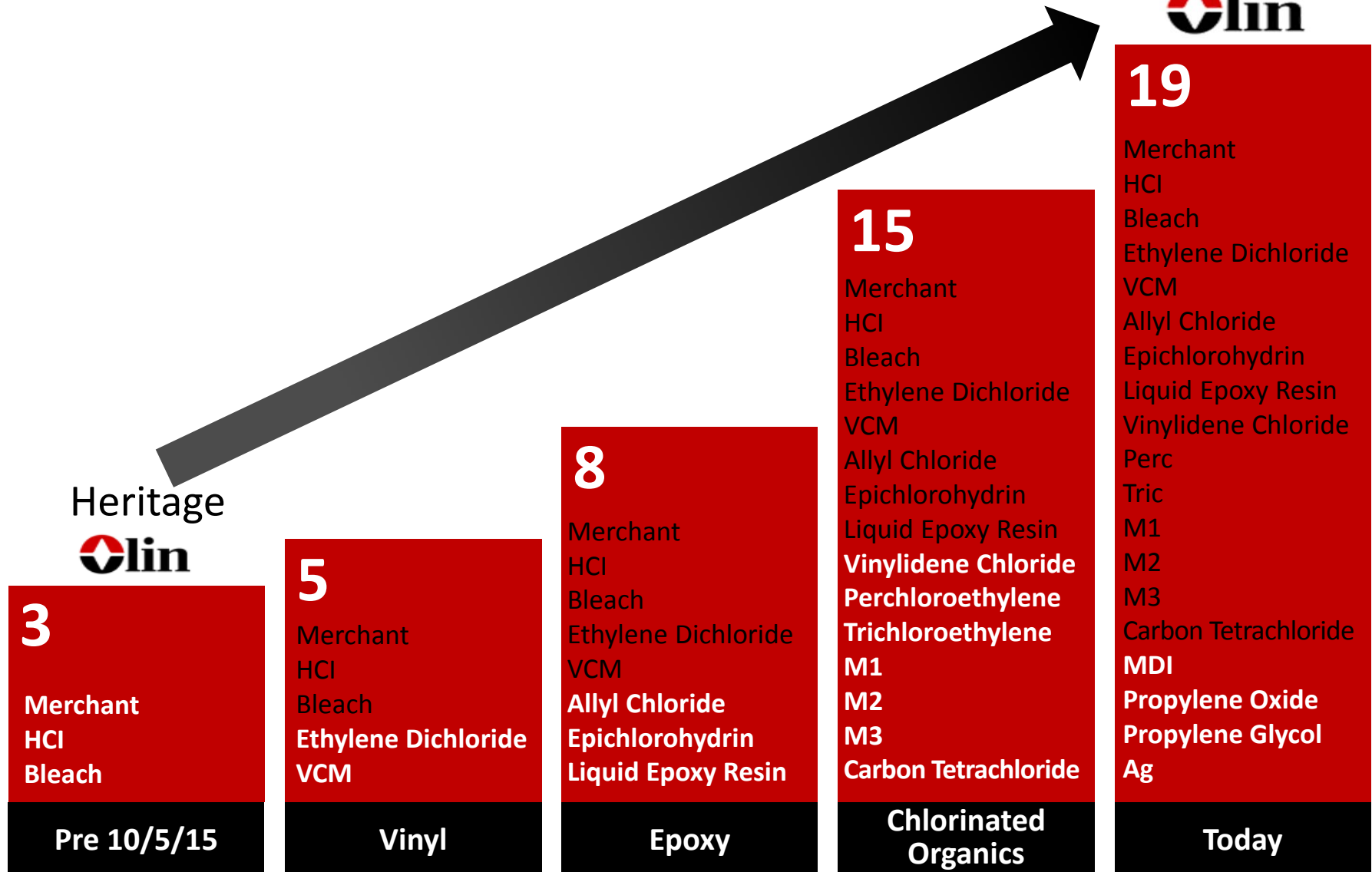

Chlor Alkali Products and Vinyls Segment Performance



(\$ in millions)

	2Q18	2Q17	Δ Q/Q
Sales	\$1,018.7	\$865.1	17.8%
Adjusted EBITDA	\$290.3	\$159.4	82.1%

- 2Q18 Performance vs. 2Q17
 - Higher caustic soda, chlorine and other chlorine-derivatives pricing, lower EDC pricing
 - Higher volumes and lower ethylene costs
 - Higher raw material and freight costs
 - 2Q18 included \$54 million of maintenance costs and unabsorbed fixed costs associated with planned maintenance turnarounds compared to \$95 million in 2Q17
- 3Q18 Outlook vs. 2Q18
 - Expect improvement in domestic caustic soda, chlorine, EDC and chlorine-derivatives pricing
 - Expect lower export caustic soda pricing
 - Expect higher volumes
 - Expect lower maintenance costs and unabsorbed fixed costs associated with planned maintenance turnarounds

Chlor Alkali Products and Vinyls Pricing Comparisons



	2Q18 versus	
	2Q17	1Q18
Chlorine	↑	↗
Caustic Soda	↑	↗
EDC	↘	↑
Bleach	↗	↗
HCl	↑	↑
Chlorinated Organics	↑	↗

Olin Caustic Soda Price Realization



Fundamental Principle

- A \$10 per ton change in Olin's caustic soda selling price changes annual Adjusted EBITDA by approximately \$30 million

Export Sales

- Typically range between 20% and 25% of caustic sales
- Sold on a combination of negotiated sales and export index price
- Realization of index price changes are typically 90% to 100%
- Changes in export index prices are typically realized on a 30 to 90 day lag

Domestic Sales

- A significant portion of domestic sales are linked to index prices
- Index price changes typically occur 30 to 60 days post our price nomination
- Realization of index price changes are typically 50% to 100%
- Overall price realization lags index price changes by 30 to 90 days

Advantaged Ethylene Arrangement



- A series of three supply agreements with Dow
- Pipeline supply without operating or start-up risk
- Producer economics for 20 years for each tranche

Tranche	Effective Date	Annual Volume (short-tons)	Cost (millions)
#1	Acquired at closing	Up to 180,000	\$433 ¹
#2	Acquired late September 2017	Up to 160,000	\$209
#3	Available ~ 4Q 2020	Up to 300,000	\$440-\$465

1. Includes option payments for Tranches #2 and #3; all options to obtain future cost-based ethylene have been exercised

Epoxy Segment Performance



(\$ in millions)

	2Q18	2Q17	Δ Q/Q
Sales	\$543.8	\$492.0	10.5%
Adjusted EBITDA	\$49.9	\$14.7	239.5%

- 2Q18 Performance vs. 2Q17
 - Higher product pricing, partially offset by lower volumes
 - Higher raw material costs, primarily benzene and propylene
 - 2Q18 included \$21 million of maintenance costs and unabsorbed fixed costs associated with planned maintenance turnarounds compared to \$18 million in 2Q17
- 3Q18 Outlook vs. 2Q18
 - Expect higher volumes
 - Expect higher raw materials costs, primarily benzene and propylene, of approximately \$20 to \$25 million
 - Expect lower planned maintenance turnaround costs of approximately \$20 million

Raw Material Costs - Benzene & Propylene Pricing

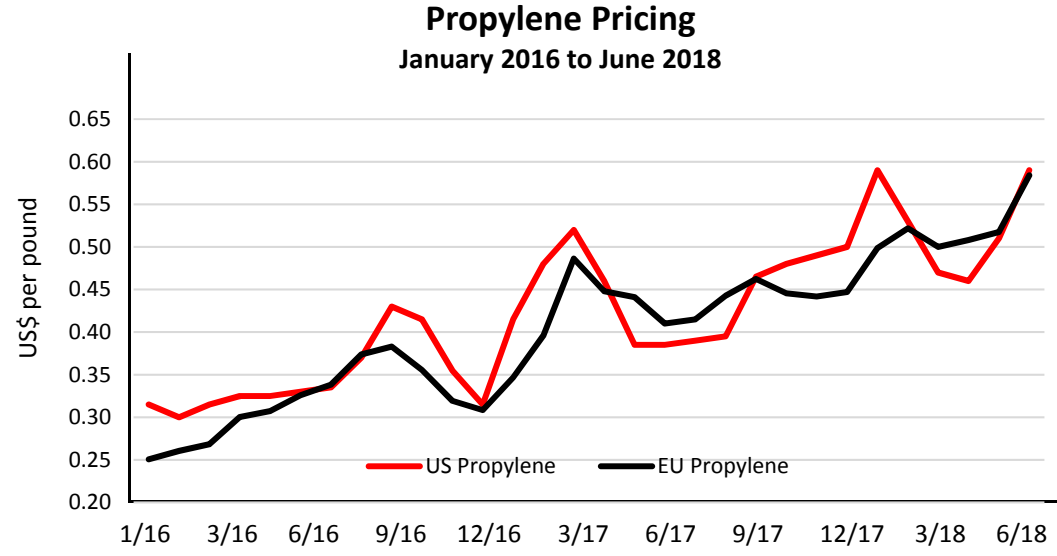
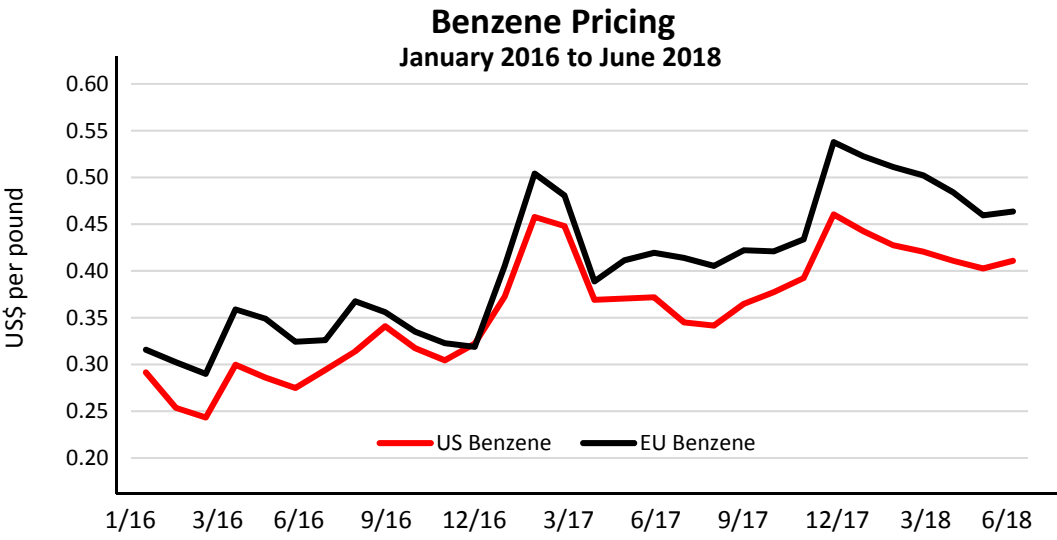

Source: ICIS

- 2Q18 U.S. benzene prices higher than 2Q17, but lower than 1Q18
- European benzene 2Q18 prices lower than 2Q17 and 1Q18
- U.S. propylene prices are higher in 2Q18 versus 2Q17, but slightly lower than 1Q18
- European propylene prices are higher in 2Q18 versus 2Q17 and 1Q18
- Recent propylene price increases a potential headwind for 2H18

Maintenance Turnaround Costs

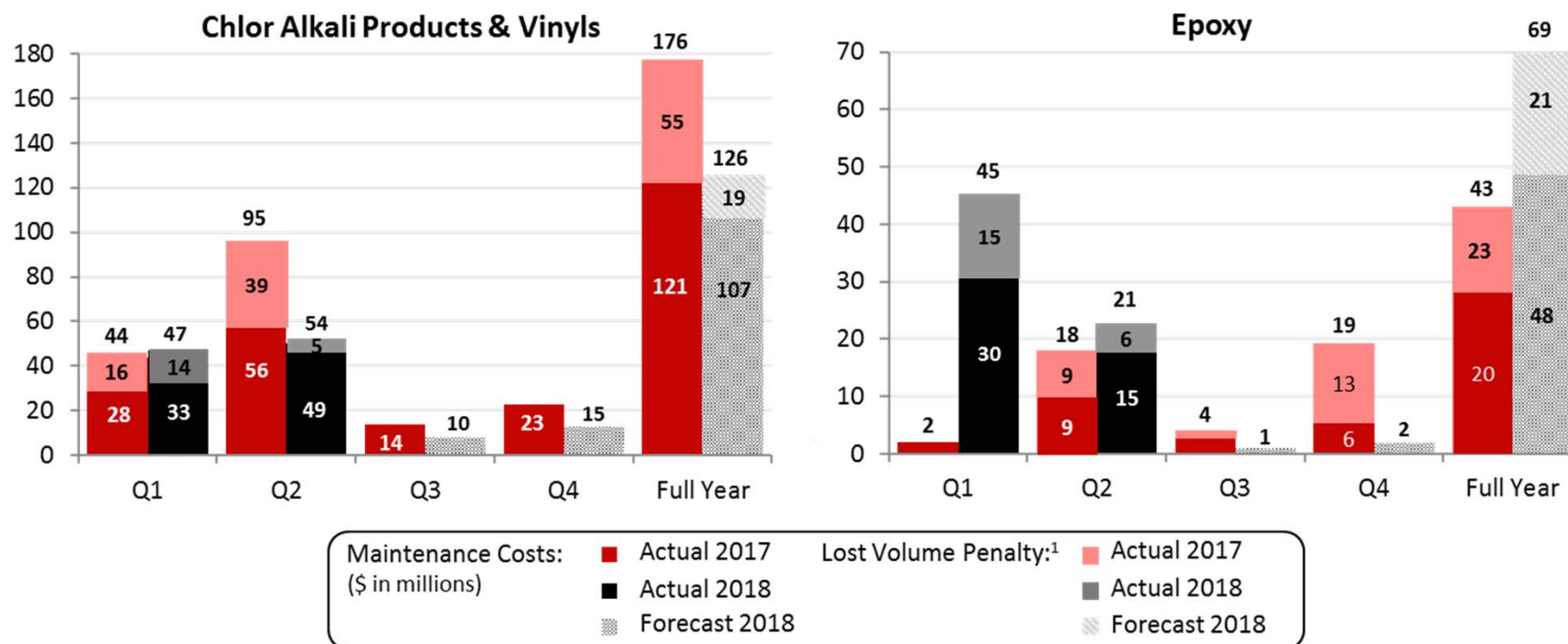

- 2H18 turnaround costs are expected to be \$135 million lower than 1H18
- Full year 2018 turnaround costs expected to be approximately \$25 million lower than 2017
- Full year 2019 turnaround costs expected to be approximately \$30 to \$40 million lower than 2018

¹: Lost volume penalty includes unabsorbed fixed manufacturing costs and reduced pretax profit from lost sales associated with the turnarounds and outages

Significant Realizable Synergies



(\$ in millions)

	Actual 2016	Actual 2017	Synergies Breakdown	Forecast 2018	Total Synergies
Logistics & Procurement					
Operational Efficiencies	\$75	\$100	Projected Annual Impact	\$75-\$100	\$250-\$275
Asset Optimization					
Accessing New Segments & Customers	\$6	\$30	Projected Annual Impact	\$50-\$65	\$85-\$100
Capital Investment	\$205	\$30	Projected CAPEX & Investments	\$0	\$235
	\$70	\$35	Projected Cash Integration & Restructuring	\$20	\$125

Winchester Segment Performance



(\$ in millions)

	2Q18	2Q17	Δ Q/Q
Sales	\$165.9	\$169.4	-2.1%
Adjusted EBITDA	\$16.7	\$23.5	-28.9%

- 2Q18 Performance vs. 2Q17
 - Lower commercial sales, partially offset by higher military sales
 - Less favorable product mix
 - Higher commodity costs, partially offset by lower operating costs
- 3Q18 Outlook vs. 2Q18
 - Expect higher commercial sales due to seasonal demand improvement
 - Expect continued strong military sales
 - Expect commodity costs to be comparable to 2Q18

2018 Forecast Assumptions



(\$ in millions)

Line Item	Forecast	Key Elements
Capital Spending	375 to 425	Maintenance level of capital spending of \$225M to \$275M annually, information technology project spending of \$100M and other projects
Depreciation & Amortization	590 to 610	Forecast is an increase from 2017 levels of \$559M
Non-operating Pension Income	20 to 25	Lower than 2017 income levels by approximately \$10M to \$15M
Environmental Expense	15 to 20	Represents a more historic level of expense
Other Corporate & Unallocated Costs	110 to 120	Forecast is an increase from 2017 levels due to legal and litigation costs
Restructuring & Acquisition Costs	70	Acquisition related integration, including information technology project and restructuring costs
Book Effective Tax Rate	25%	Reflects 2017 tax law changes and favorable book/tax deductions, partially offset by state and foreign income taxes
Cash Tax Rate	10% to 15%	Reflects 2017 tax law changes and 2017 tax credit carryforwards benefits; primarily paying foreign income taxes in 2017

Non-GAAP Financial Measures – Adjusted EBITDA ^(a)



Olin's definition of Adjusted EBITDA (Earnings before interest, taxes, depreciation, and amortization) is net income (loss) plus an add-back for depreciation and amortization, interest expense (income), income tax expense (benefit), other expense (income), restructuring charges, acquisition-related costs and certain other non-recurring items. Adjusted EBITDA is a non-GAAP financial measure. Management believes that this measure is meaningful to investors as a supplemental financial measure to assess the financial performance without regard to financing methods, capital structures, taxes or historical cost basis. The use of non-GAAP financial measures is not intended to replace any measures of performance determined in accordance with GAAP and Adjusted EBITDA presented may not be comparable to similarly titled measures of other companies. Reconciliation of forward-looking non-GAAP financial measures to the most directly comparable GAAP financial measures are omitted from this release because Olin is unable to provide such reconciliations without the use of unreasonable efforts. This inability results from the inherent difficulty in forecasting generally and quantifying certain projected amounts that are necessary for such reconciliations. In particular, sufficient information is not available to calculate certain adjustments required for such reconciliations, including interest expense (income), income tax expense (benefit), other expense (income), restructuring charges and acquisition-related costs. Because of our inability to calculate such adjustments, forward-looking net income guidance is also omitted from this release. We expect these adjustments to have a potentially significant impact on our future GAAP financial results.

(In millions)	Three Months Ended June 30,		Six Months Ended June 30,	
	2018	2017	2018	2017
Reconciliation of Net Income (Loss) to Adjusted EBITDA:				
Net Income (Loss)	\$ 58.6	\$ (5.9)	\$ 79.5	\$ 7.5
Add Back:				
Interest Expense	61.1	52.5	124.8	104.9
Interest Income	(0.4)	(0.4)	(0.8)	(0.6)
Income Tax Provision (Benefit)	15.7	(15.9)	22.3	(11.4)
Depreciation and Amortization	150.7	137.1	297.4	272.2
EBITDA	285.7	167.4	523.2	372.6
Add Back:				
Restructuring Charges (b)	6.4	8.5	10.4	16.7
Acquisition-related Costs (c)	0.3	4.4	0.6	11.4
Information Technology Integration Project (d)	11.5	-	18.0	-
Certain Non-recurring Items (e)	21.5	-	13.5	-
Adjusted EBITDA	\$ 325.4	\$ 180.3	\$ 565.7	\$ 400.7

(a) Unaudited.

(b) Restructuring charges for the three and six months ended June 30, 2018 and 2017 were primarily associated with the closure of 433,000 tons of chlor alkali capacity across three separate Olin locations.

(c) Acquisition-related costs for the three and six months ended June 30, 2018 and 2017 were associated with our integration of the Acquired Business.

(d) Information technology integration project for the three and six months ended June 30, 2018 included costs associated with the implementation of new enterprise resource planning, manufacturing, and engineering systems, and related infrastructure costs of \$11.5 million and \$18.0 million, respectively.

(e) Certain non-recurring items for the three and six months ended June 30, 2018 included a \$21.5 million pretax non-cash impairment charge associated with our investments in non-consolidated affiliates. Certain non-recurring items for the six months ended June 30, 2018 also included an \$8.0 million insurance recovery associated with a second quarter 2017 business interruption at our Freeport, Texas vinyl chloride monomer facility.

Non-GAAP Financial Measures by Segment



(In millions)	Three Months Ended June 30, 2018				Three Months Ended June 30, 2017		
	Income (loss) before Taxes	Certain Non-recurring Items (a)	Depreciation and Amortization	Adjusted EBITDA	Income (loss) before Taxes	Depreciation and Amortization	Adjusted EBITDA
Chlor Alkali Products and Vinyls	\$ 149.4	\$ 21.5	\$ 119.4	\$ 290.3	\$ 52.8	\$ 106.6	\$ 159.4
Epoxy	24.8	-	25.1	49.9	(8.1)	22.8	14.7
Winchester	11.8	-	4.9	16.7	19.0	4.5	23.5

(In millions)	Six Months Ended June 30, 2018				Six Months Ended June 30, 2017		
	Income (loss) before Taxes	Certain Non-recurring Items (a)	Depreciation and Amortization	Adjusted EBITDA	Income (loss) before Taxes	Depreciation and Amortization	Adjusted EBITDA
Chlor Alkali Products and Vinyls	\$ 279.9	\$ 21.5	\$ 233.1	\$ 534.5	\$ 140.3	\$ 211.2	\$ 351.5
Epoxy	2.7	-	51.8	54.5	(9.3)	45.2	35.9
Winchester	23.8	-	10.0	33.8	44.1	9.4	53.5

(a) Certain non-recurring items for the three and six months ended June 30, 2018 included a \$21.5 million pretax non-cash impairment charge associated with our investments in non-consolidated affiliates. Earnings (losses) of non-consolidated affiliates are included in the Chlor Alkali Products and Vinyls segment results consistent with management's monitoring of the operating segments.